



***Built-in hob  
ceramic***

***OV 643 T  
OV 645 TI  
OV 646 TA  
OV 669 TI***

---

It is our ultimate desire that you achieve the best performance from our product, which has been passed through meticulous quality control checks and is manufactured in modern facilities.

**To this effect, we recommend that you read the entire guide carefully before operating the product and keep it as a reference.**



This product has 10 years life span.

It means that said period is time interval to stock its spare parts to keep this product functional.

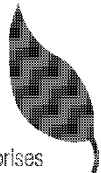

The unit was produced in modern enterprises ) corresponding to environmental standards.



# Table of Contents

---

<b>1. Technical Specifications.....</b>	<b>02</b>	<b>Sensor calibration and Error</b>	
Your Appliance .....	03	<b>Messages .....</b>	<b>18</b>
<b>2. Important Information.....</b>	<b>04</b>	<b>5. Care and Maintenance .....</b>	<b>19</b>
<b>3. Preparation and installation .....</b>	<b>07</b>	Ceramic hob care .....	19
Usage of the assembly clamp.....	08	Saucepan types .....	19
Electrical Connection .....	09	Deep fat frying .....	20
Broiler Zone .....	09	<b>6. Cleaning .....</b>	<b>20</b>
<b>4. Operating the Hob .....</b>	<b>10</b>	<b>7. Trouble shooting .....</b>	<b>22</b>
<b>Control Elements and Display .....</b>	<b>10</b>	<b>8. Future transportation .....</b>	<b>22</b>
Turn on the hob .....	11	<b>9. Warranty terms and conditions ..</b>	<b>22</b>
Select hotplates .....	11		
Heat Boost .....	12		
Turn of the hob .....	12		
Turn on dual and triple zone .....	13		
Key lock .....	14		
Child lock .....	14		
Timer function .....	15		
Operating time limitation .....	17		
Residual heat function .....	17		

# 1 Technical Specifications

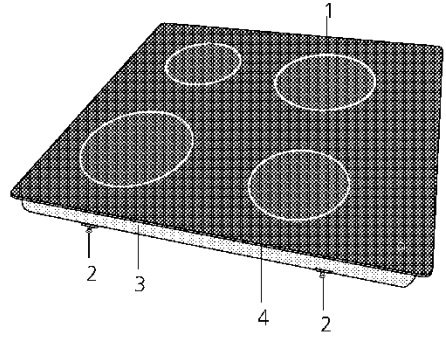

- 1. Ceramic hot plate
- 2. Assembly clamp
- 3. Protection cover
- 4. Burners plate

The graphics and figures are for illustration purposes only. The actual view may be differ.

<b>External dimensions</b>	<b>60 cm</b>	<b>80 cm</b>
Width	580 mm	770 mm
Depth	510 mm	510 mm
Height	55 mm	55 mm
<b>Dimensions of installation setting</b>		
(•) Width	560 mm	750 mm
Depth	490 mm	490 mm
Supply voltage	220- 240V N/ 380-415V 2N ~ 50Hz	

# Your Appliance

The cooking zones are labelled by markings on the glass ceramic plate.

60 cm			.....	OV 643 T	OV 645 TI	OV 646 TA	.....	.....
WATT	DIA	SHAPE						
2200/750	210/120	DUO			X	X		
1200	140	SINGLE		X	X	X		
1500	160	SINGLE		X	X	X		
2000/1100	140/240	EXT.ROAST						
2000/1100	140/250	EXT				X		
2400/1500	170/265	EXT						
1800	180	SINGLE		X	X			
2300	210	SINGLE		X				
1700/700	180/120	DUO						
2300/800/800	210/175/120	TRIPLE						
110 - 80	260X170	SINGLE						
2700/2200/1050	275/210/145	TRIPLE						
2000/600	210/120	DUO						
2500/1600/800	230/180/120	TRIPLE						
<b>TOTAL POWER</b>			<b>6000</b>	<b>6800</b>	<b>6700</b>	<b>6900</b>	<b>7000</b>	<b>5600</b>

80 cm			.....	.....	.....	OV 669 TI	.....	.....
WATT	DIA	SHAPE						
2200/750	210/120	DUO						
1200	140	SINGLE	X	X	X		X X	X
1500	160	SINGLE		X	X			X
2000/1100	140/240	EXT.ROAST						X
2000/1100	140/250	EXT		X				X
2400/1500	170/265	EXT	X			X		
1800	180	SINGLE	X					
2300	210	SINGLE						
1700/700	180/120	DUO						
2300/800/800	210/175/120	TRIPLE						
110 - 80	260X170	SINGLE						
2700/2200/1050	275/210/145	TRIPLE						
2000/600	210/120	DUO	X		X		X X	X
2500/1600/800	230/180/120	TRIPLE		X				
2100/1750/900	350/200/145	KOMBI (KEY)				X		
2400/1500	230/180	DUO					X	
110		WARMING PLATE			X	X		X
<b>TOTAL POWER</b>			<b>7400</b>	<b>7200</b>	<b>7200</b>	<b>5400</b>	<b>7200</b>	<b>6800</b>

## 2 Important Information

### Look after yourself, family and friends



- **The appliance is not intended for use by young children or infirm persons without supervision.**

**Young children should be supervised to ensure that they do not play with the appliance.**

**WARNING: To avoid risk of electric shock, immediately switch off the appliance from the mains to avoid the possibility of an electric shock if a crack is detected on the ceramic glass surface caused by mechanical impact.**

**You should contact our customer service department.**

- It is therefore advisable to have the glass secured against breakage in the household and personal effects insurance.
- If the appliance is to be installed above a cupboard, than a barrier is to be installed. Please refer to installation instructions.
- During use surfaces get hot. Don't touch hot surfaces during use.
- Don't store items above the appliance that children may try to reach.
- Close supervision while cooking is essential at all times.
- When deep-frying, the appliance should be supervised as overheated fats and oils can catch flame easily. Never attempt to extinguish burning oil or fat with water (risk of explosion!). Smother a fire with wet towels and keep doors and windows closed!
- Ensure handles of pans can not accidentally be caught or knocked and do not get heated by adjacent heating zones.
- Check all controls on the appliance are switched off after use.

### Look after your appliance and home



- Clean your appliance regularly, ideally after each use. Always turn off the mains electricity supply and allow the appliance to cool first.
- Spillage should be dealt with as soon as it occurs, taking due care as the appliance surface may be hot. Any spillage left on the surface after cooking should be cleaned off before the appliance is switched on again to prevent baking on.
- Don't use biological washing powder or bleach products, harsh abrasives or chemical cleaners for cleaning.
- Ensure that no flammable materials are adjacent to the appliance as the sides become hot during use.
- Don't place flammable or plastic items on or near the appliance, and never place wet cloths etc. on the appliance to dry.
- Don't leave an appliance on for long periods when not covered by a pan.
- Don't use water to extinguish oil or fat fires.
- Don't heat up unopened food containers as pressure can build up causing the container to burst.
- Don't use round-bottomed traditional woks. Use flat-bottomed types.
- Do not use a steam cleaner with to clean this appliance.
- Don't stare at the halogen appliance.
- The surfaces of the stainless steel model appliances which are close to the burners may change colour because of the excessive heat in the course of time.

## Important Safety Information



This appliance is in accordance with the recognized state of the art and the relevant safety provisions. In order to prevent damages and accidents, however, the proper handling of the appliance is a prerequisite. Along with the following information, please take note of further information contained in the text.

- Do not put the appliance into operation if there are visible damages such as cracks or splits in the glass ceramic-plate surface. In this event, please contact our customer service department.
- No alterations or repair attempts, in particular using tools (screwdrivers, etc.) may be undertaken to or on the appliance. Trained professional who have been specially schooled for this appliance may only perform repairs, in particular to electrical supply parts. Improper repairs could lead to serious accidents, damages and breakdowns.

In the event of a breakdown of the appliance, (before contacting our customer service department), please take note of the information contained under "Warranty terms". Please contact our customer service as needed.

### How to use:

- Infirm or mentally handicapped persons and persons who are not able to operate the device properly due to inexperience or lack of knowledge, should use this device under close supervision only. This applies to children, too.

- The glass ceramic hob may only be used for the preparation of food items in the domestic household. In the event that the appliance is misused for another purpose or improperly handled, no liability for possible damages can be assumed.
- Do not use the hob to heat the room.
- As soon as a functional disturbance is detected or if, e.g. due to extreme mechanical effects, cracks appear in the

glass ceramic plate, the device must be put out of operation immediately: turn off the device and disconnect it from the electrical mains network (unscrew fuses or respectively deactivate automatic circuit breakers).

- Connection cables of electrical devices should not be exposed to hot cooking zones or the cookware. The electrical insulation may become damaged as a result.

### This is how you can avoid damages to your glass ceramic hob

The glass ceramic plate is non-sensitive to heat (up to 650°C) and temperature fluctuations as well as being break-proof and scratch-resistant to a certain degree. Nonetheless, please observe the following information in order to prevent damages:

- In no event should you pour cold water over the hot burners.
- Do not climb onto the glass ceramic plate.
- A sudden stress could become critical, e.g. during the impact of a saltshaker. Therefore, it is best that you do not store such items above the hob.
- Before each use, you should ensure that the base of the cookware as well as the surfaces of the cooking zones are clean and dry.
- Always lift and do not drag cookware in order to prevent scratching of the glass ceramic plate and wear and tear to the décor.

- Avoid peeling vegetables upon the hob surface. Grains of sand can scratch the glass ceramic plate.
- Do not use the hob as a storage surface; in particular, do not lay any flammable materials, cartons or plastic packages upon it. Objects made of pewter, zinc or aluminium (also aluminium foils or an empty espresso maker) could melt on hot cooking fields and cause damages.
- Take care that no sugar-containing foods or juices come into contact with hot cooking zones. The surface of the glass ceramic plate could be strained as a result. Remove overflows immediately, even while still in a hot state.
- Do not place hot pots or pans on the frame of the burner.
- When cleaning, care should be taken that no water penetrates the appliance, as penetrating water could cause damages. Therefore, you should only use moist cloths. Never squirt water onto the appliance and refrain from using steam cleaners.

### **Pertaining to Disposal:**

- Please separate the packaging materials for recycling and dispose of it at a public rubbish collection location. Packaging materials are not toys for children.
- Permanently connected devices (without plug) must be disconnected from the mains network before removal by a licensed electrician.
- Make the device non-functional before disposal: Cut off mains cable (after unplugging) or any existing loose connection cables on the device.
- Make sure that the appliance is disposed of properly.

### **Natural ventilation is important for the correct functioning of the appliance and your own safety.**

Prolonged intensive use of the appliance may call for additional ventilation, for example the opening of a window, or the use of permanent fixed mechanical ventilation system, for example, an extractor fan or cooker hood that ventilates to the outside.

### **Food hygiene**

- Ensure meat and poultry is thoroughly defrosted before cooking.
- Check food is thoroughly cooked and is piping hot.
- **Always refer servicing to a qualified appliance service engineer.**

### **Important for asthmatic sufferers**

Before using for the first time, protective coatings need to be burnt off. Fumes will be emitted but this is quite normal.

**Ensure the room is very well ventilated during the burning off process. Avoid directly inhaling the fumes during this process.**

### 3 Preparation and installation

#### Assembly of the Built-in Hob



This built-in hob is intended to be fitted into a hollow in a tabletop. Fitting may only be performed by a trained professional. An electrical professional must connect the appliance to the mains network. Thereby, the local safety provisions as well as the technical connection provisions of the local electrical supply company must be observed. An all-pole separator with a contact

opening of at least 3 mm must be built into the house installation (screw-retaining devices, earthed conductor switch, main switch).

The distance from one high side wall to the side hollow corner must amount to at least 50 mm.

If a stove is to be fitted underneath the hob, it must be ventilated.

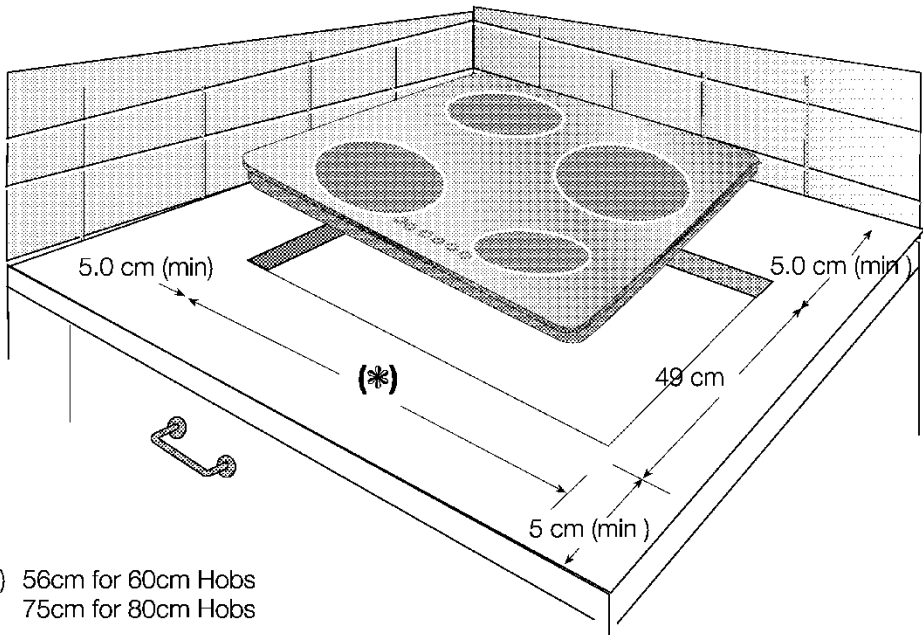

(\*) 56cm for 60cm Hobs  
75cm for 80cm Hobs

In addition, you can install your hob according to the illustrated figure by means of assembly clamp. Use of assembly clamp may change according to your model.

## Usage of the assembly clamp (if available)

1. If the counter thickness is 3 cm;
2. If the counter thickness is 4 cm;

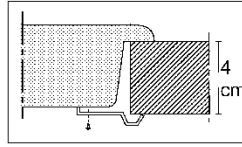
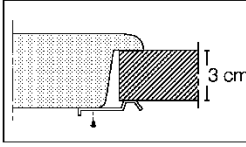

In this alternative; the assembly clamp will be screwed from the second hole.

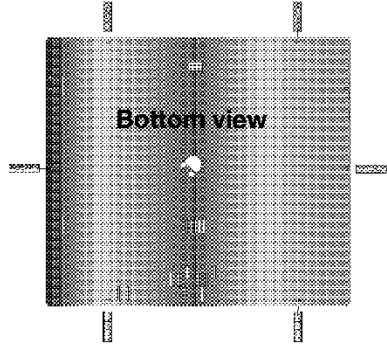

For worktop thickness's of less than 30 mm insert a wood spacer between the bracket and the under surface of the worktop.

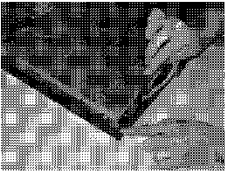
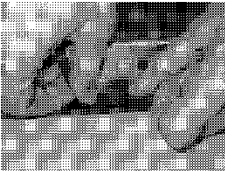

1. Prepare the worktop as shown.
2. Remove the sealing gasket from the packaging.
3. The sealing gasket provided in the package must be affixed around the glass frame on the lower surface during the installation of your hob as shown.
4. Position the appliance centrally in the worktop.
5. Tighten the screws of the springs located on the base of the appliance to secure the appliance in position.

**Attention:** When installing the hob above a cupboard, a diving shelf as pictured above must be installed. If installing above an underbench oven this is not required.

**If, for example, due to the fitting of the appliance above a drawer, the underside of the appliance is touchable, it must be covered by a wooden plate.**

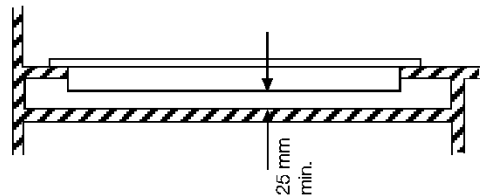

## Electrical Connection

- Do not connect the appliance to the electricity supply until all packing and transit protectors have been removed.



Before your appliance is connected to the mains electricity supply, check to ensure that the voltage and frequency shown on the rating label corresponds with your power supply.

- Before applying to Authorized service, have the electrical wiring of your home ready for connection.

This product must only be installed by a qualified electrician

### Warning!

**This appliance must be earthed.**

If the mains connection lead is damaged, it must be replaced by a special connection lead which is available from our customer service department.

**The cable length should be 2 m. max for isolation safety.**

- The mains cable must pass through the cable clamp.
- The mains cable should be routed away from the appliance.

### Broiler Zone

Selective heating of the internal cooking zone

- A**, or
- A** and **B** together, or
- A** and **B** and **C** together



**Tri-circuit-cooking zone**



**Single -circuit-cooking zone**

Our company shall not held responsible for any damage caused by the utilisation of the oven without ground socket.

The appliance must be connected with the supplied original cable or technically equivalent cable of the type H05RRF 3G 2.5 or H05RRF 5G 1.5.

- If a cable is provided together with your appliance

- Connection;
  - Brown (3x2,5), Black & gray (for 5x1,5) to live wire
  - Blue to neutral wire
  - Yellow/green to earth

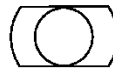
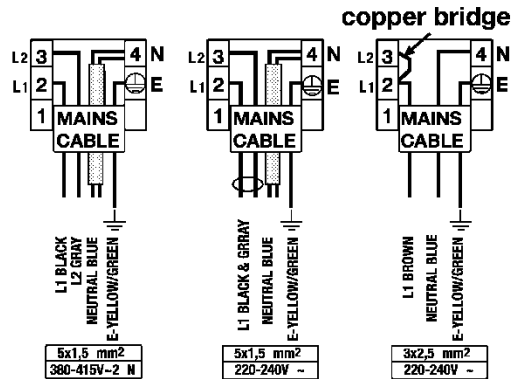

**Single-circuit hotplate with extended cooking zone**



**Extended cooking zone**



**Dual-circuit hotplate with extended cooking zone**



**Dual-circuit-cooking zone**







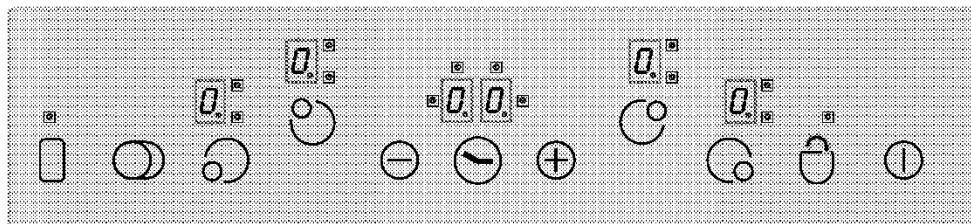



**The fast radian (halogen), extended and dual plates burn with that brilliant light when they are first ON.**

# 4 Operating the Hob

## Control Elements and Displays





### Features

-  Main switch - ON/OFF Key
-  Key lock
-  Heat setting/Timer increase
-  Heat setting/Timer decrease
-  \*\* Dual/triple zone-Selection Key
-  \* Activate/deactivate timer
-  \*\* Activate/deactivate warming zone
-  Hotplate (cooking zone)  
Selection controls
-  Hotplate display (heat setting 0...9)
-  Dual/Triple zone in operation display  
via LED (Hotplate display)
-  \* Timer display (4 LED assigned for 4  
different hotplate)

### Note :

- This appliance controls via the touch control unit. If your touch control unit has a timer, each operation is confirmed with an audio signal.
- Always keep the control panels clean and dry. Moisture and dirt may impair function.

\*\*   If your hob is equipped with these functions

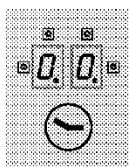

\*\*  in models with timer.

- The graphics and figures are for illustration purposes only. The actual view or functions may differ.



(\*) If your hob is equipped with timer.

## Turn on the hob

Touch the “” key in the control panel at least 1 second. The hotplate displays will light up. The hob is ready for use. You can now turn on (select) different hotplates within next 10 seconds. While operating the main switch “”, it is not allowed to operate other controls.

All hotplate displays flashes “” and all related decimal points.

## Select Hotplates (Cooking Zone)

1. Turn on the hob.
2. Touch one of the hotplate selection control of desired hotplate. After selection of the hotplate, the decimal point of the related hotplate display “” flashes.



**The hob will be set automatically stand by mode if there is no operation within 10 seconds.**

If the main switch “” is touched more than 2sec, the hob is turned off and is set into the stand-by mode again.

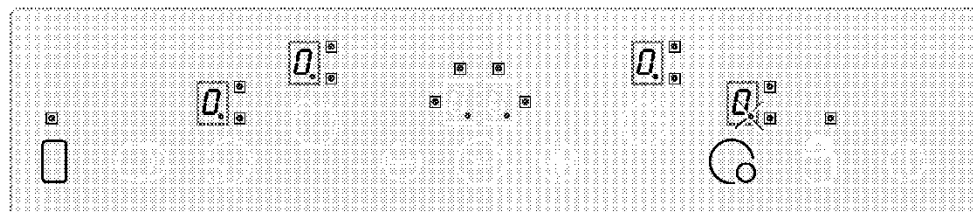

**The hob will be set automatically stand by mode if there is no operation within 10 seconds.**

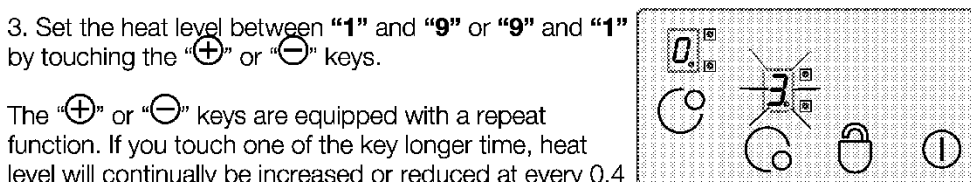

3. Set the heat level between “1” and “9” or “9” and “1” by touching the “” or “” keys.

The “” or “” keys are equipped with a repeat function. If you touch one of the key longer time, heat level will continually be increased or reduced at every 0,4 second.



If you begin with “” key, “1” will appear. If you begin with “” key, the display will show setting value (e.g. half second “A” and half second “9”). This means Heat Boost is active now.

## Heat Boost

This function makes cooking easier. If the heat boost is active, then the hotplate will be operated with maximum power for a period of time (see table-1). Heat boost time is depending on selected heat level. This is indicated through a flashing “A” alternating with the heat setting value (e.g. half second “A” and half second “9”) in the hotplate display. At the end of the heat boost time, hob will turn down the heat setting value you selected will be indicated continually.

Every hotplate is a equipped with heat boost functionality.

### Turn On Heat Boost Feature :

1. Turn on the hob.
2. Select desired hotplate by touching hotplate selection keys.
3. Select the hotplate heat settings value “9” using “⊖” key. After heat setting, “9” and “A” will be indicated alternating. This means heat setting value “9” and heat boost feature is active now.
4. Then set the desired heat setting value at which the cooking will continue at the end of heat boost time, using “⊖” key within 10 seconds. By touching the “⊕” or “⊖” keys of the hotplate, the heat setting between “9” and “1” can be used. (e.g. you set the level 6).
5. The display alternates during heat boost cooking between “A” and “6” (e.g.) At the end of the heat boost time “6” will be indicated continually.

### Turn Off Heat Boost Feature :

- The heat boost can be turned off early by touching the “⊖” key until heat setting “0” appears.
- If heat setting “9” will be chosen as under selection of the heat boost and no

low heat setting is chosen, the flashing will be finished after 10 seconds. The heat boost is not longer active.

## Turn Off The Hob

If the main switch “⊕” is touched more than 2sec, the hob is turned off and is set into the stand-by mode again.

If there is a residual heat available when the hob is turned off, this will be indicated by a steady 🔥 in the relevant hotplate display.

## Turn Off Individual Hotplates :

A selective hotplate can be turned off with 3 different ways:

1. Simultaneous touching of the “⊕” and “⊖” keys
2. Reduction of the heat setting to “0” by touching the “⊖” key
3. Use of timer turn off function for related hotplate. (If timer function is available)

### 1. Simultaneous operation of the “⊕” and “⊖” keys

The desired hotplate must be chosen with the hotplate selection “ⓐ” key . The decimal point appears in the hotplate display “0.0”. The “⊕” and “⊖” keys must be touched at the same time to turn off the hotplate.

### 2. Reduction of the heat setting to “0” by operating the “⊖” key of the desired hotplate

The hotplate can also be turn off by reducing the heat setting to “0”.

### 3. Use of timer turn off function for desired hotplate (If timer function is available)

The timer turns off the linked hotplate when the time has run out. All displays indicates "0" and "00". Dual/ Triple zone and timer linked LEDs will be disappear.

Additionally when the time has run out, the buzzer will sound. You have to touch any key on touch control panel to stop the buzzer sound.

### Turn On Dual and Triple Zones\*\*

#### Turn on the dual zone :

The desired hotplate equipped with a dual zone must be selected. The decimal point of the relevant hotplate must be flash. After setting the heat setting value 1-9, touch "0" key to activate the dual zone of the hotplate.

At the same time, the related dual zone LED flashes statically. Touching the "0" LED flashes statically. Touching the "0" LED flashes statically. Touching the "0" LED flashes statically.

"0" key for a second time, the status of the dual zone toggles: it changes from dual zone on to dual zone off and back again.

The extension zone can be activated only, after a level between "1" and "9" is set on the basic zone of the hotplate.

#### Turn on triple zones :

The desired hotplate equipped with a triple zone must be selected. The decimal point of the relevant hotplate must be flash. After setting the heat setting value 1-9, touch "0" key to activate the dual zone of the hotplate.

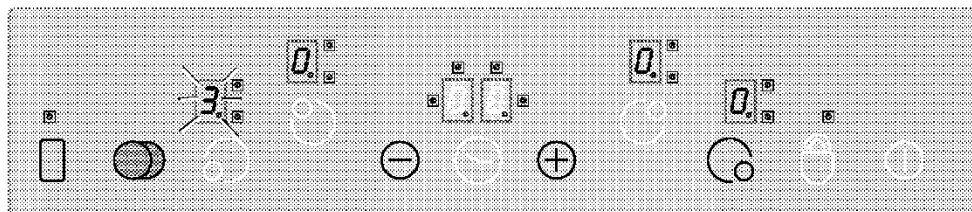

At the same time, the related dual zone LED goes on statically. If you touch "0" key again, The triple zone-LED will be flashed and the triple zone will be energized.

**After touching the "0" key once again, the triple zone of the hotplate will be turned off again. Each operation causes a status change of the dual/triple zones following in this manner.**





Activating the dual and triple Hotplate by touching "0" Key of the selected hotplate.

## Key Lock\*\* (In models with timer)

Touch “” key more than 2 seconds to lock Touch Control. You will be acknowledged by a audio signal. Afterwards “” LED flashes and all hotplates are locked.

The hotplate can only be locked in operating mode. If the hotplate is locked,

only the main switch- “” key can be operated. The “” LED flashes and indicates a key locked module. If you turn off the hob when keys are locked, key lock will be still active after you restart the hob again. In order to operate the hob in a such condition, key lock should be unlocked.

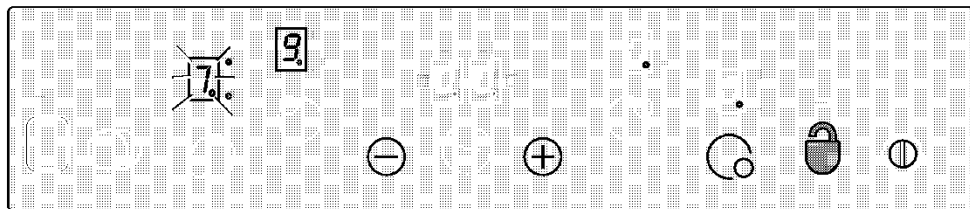

**Lock or unlock the Touch control in operation mode by touching the “” key.**

If the “” key is touched 2 seconds, the hotplate is unlocked. You will be acknowledged by a audio signal.





Afterwards the “” LED disappears. Now, the touch control is unlocked and can be operated in normal order.

## Child Lock

To prevent children from turning on the hotplates, you can secure the hob against being turned on inadvertently. Child Lock functionality is foreseen to lock the touch control unit in a complicated Multi-Step process.

Child Locking and unlocking is only available in the Stand by -mode.





### How to lock the module:



1. Turn on the hob using main switch “”.
2. Simultaneously touching the “” and “” for at least 2 sec.
3. Then touch again “” key.

Child lock function will be activated and all hotplate displays will indicate  symbol.

### Cancel Child Lock:

The same way the Child lock is activated, it can also get for deactivating.

1. Turn on the hob using main switch “”.
2. Simultaneously touching the “” and “” keys for at least 2 sec.
3. Then touch again “” key.

All hotplate display is indicated  during period of unlocking.  will be disappear immediately after successful unlocking.

## Timer Function \*

This feature facilitates the cooking for you. You do not need to be permanently present during the cooking procedure ; the hotplate is automatically turned off at the selected time.

### Egg timer:

**The egg timer is independent of any hotplate. So it doesn't matter whether a hotplate is selected or not.**

1. Start to activation of egg timer by touching “⊖” key. The timer display will indicate “00” and a dot in the right bottom side . The egg timer is active now.
2. Then set the desired time value by touching “+” and “⊖” keys.
3. After setting the, time the timer starts to countdown.

When the time has run out, the buzzer will sound. You have to touch any key on touch control panel to stop the buzzer sound.

**Hotplate timer :**  
**Hotplate timers can be set only for activated hotplate.**

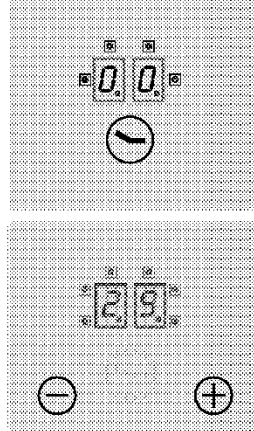

1. Firstly turn on the hob and activate desired hotplate. (hotplate level must be set to 1-9 before)
2. Start to activation of hotplate timer by touching “⊖” key same as with egg timer. The timer display will indicate “00” and a dot in the right bottom side . The egg timer is active now.
3. You have to touch “⊖” key second time to activate the hotplate timer. Now the timer can be assigned.

The timer provides following features:  
Touch control can run max. 4 hotplate assigned timers and 1 egg timer simultaneously. All timers can be used only in operation mode.



4. Set the desired time value with “+” and “⊖” keys.

**To set additional hotplate timers :**

1. Touch “⊖” key again after activating the first hotplate timer. The control rotates clockwise to the next active hotplate assigned to a timer. The assignment recommendation is indicated by the flashing “” led.
2. Set the desired time value with “+” and “⊖” keys.
3. The running timer of the first set hotplate timer is indicated by the statically lighting “” LED.

- Touching the “⊖” key once again further timers can be assigned to other activated hotplates.
- The timer display will change to time that will end first after 10 sec.
- The statically on LEDs  on timer display identify us the running timers.
- By toggling the “⊖” key you can display

the timer values for the hotplate timers and the egg timer. The assignment is always indicated by the flashing Front left led .

If no led flashes, the Egg timer value is shown in the timer display.

### Cancel Timers :

Firstly you have to select the timer by toggling the “⊖” key until it is displayed. The value can be canceled then in 2 different ways:

- decrement by touching the “⊖” until “00” appears on the timer display.
- touch the “⊕” and “⊖” key

simultaneously for half second until “00” is shown in Timer display.

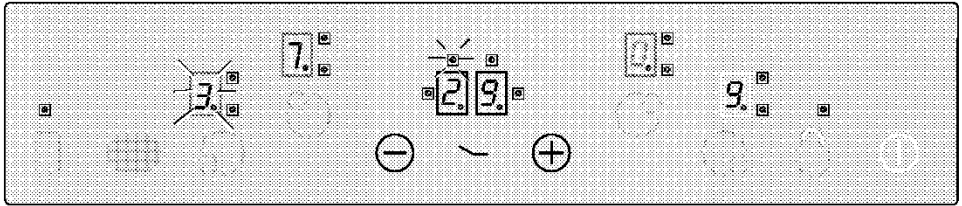

When the time has run out, the buzzer will sound. You have to touch any key on touch control panel to stop the buzzer sound.



Display remaining value of hotplate timer 3 (indicator led flashing) in Timer Display (Indicators leds are on indicate running timers for hotplate 1 and 4, actually not displayed in timer display)

### Warming plate function (if available)

Warming Plate functionality for a warming zone offers an means an additional heat level between 0 and 1 keeping the food warm. You can activate Warming Plate functionality by touching the  key .

Then LED  will flash. Touch  again to deactivate warming zone.

## Operating time limitations

The hob control has a limitation of the operating time. If one or more hotplates are inadvertently not switched off, hotplate will be automatically deactivated after a certain amount of time. (see table-1 below) The limit of the operating time depends of the selected heat setting. If a timer was associated with the hotplate

than a “00” will be displayed on the timer display for 10 seconds.( after 10 seconds residual heat indicator will light). Afterwards the timer display switches off.

After an automatic switch off of the hotplate, as described above, the hotplate is re-operable again and the maximum operating time for this heat setting is applied.

Heat setting	OFF- Time period in s	ON- Time period in s	Operating time limitation in h	Heat boost duration in s
0	0	0	0	-
U	45,9	1,1	6	-
1	45,6	1,4	6	60
2	43,6	3,4	6	180
3	41,3	5,7	5	288
4	38,4	8,6	5	390
5	35,9	11,1	4	510
6	33,1	13,9	1,5	150
7	26,2	20,8	1,5	210
8	19,2	27,8	1,5	270
9	0	47,0	1,5	-

**Table -1:** Heat setting parameters, Cycle Time 47,0 s

## Residual Heat Functions

An “H” (residual heat) lights up on the hotplate displays of a deactivated hotplate or hob if a surface temperature of over 60°C was determined for the hob. A “0” will light up on the display when the residual heat falls down from 60°C.

After an interruption of the supply voltage occurred, that the residual heat display flashes, if the corresponding hotplate had a residual heat of greater than 60 °C before the power interruption occurred. The display will flash until the max. residual heat time has expired or the hotplate will be selected and activated.

## Sensor Calibration and Error messages

The hob control performs an automatic calibration in reference to the sensor-, glass- and ambient conditions after the main voltage is applied. No objects are allowed to cover the glass area of the sensor during the calibration. In addition, the hob control cannot be exposed to strong illumination, like sunlight, strong halogen lights, etc.

Error reason	Display
Ambient light too high	<b>F1</b>
Strong pulsating light (fluorescent tube)	<b>F2</b>
Sensor covered with a bright object	<b>F3</b>
Strongly fluctuating ambient light	<b>F4</b>

**Table-2:** Error codes and source of errors

### Application Example:

**The calibration performs without any problems if the following illumination is present:**

Illumination through a light bulb without reflector (100W, opal) in a distance of 70 cm above the glass ceramic hob.

After a successful calibration the function of the hob is also guaranteed even with strong illumination, for example with halogen spot with reflector ( 50W).

In case of an error, the calibration is repeated until the ambient conditions allow a successful calibration. The operation of the hob control is only possible, if the calibration of all sensors were successfully completed.

You must remove all objects on the hob during calibration process. Furthermore the ambient light should not be too high during the calibration. In case of the message F2, F3 or F4 the user should switch off all ambient light sources or cover the window for the time of the calibration process after the first connection to the power line. After successful finished calibration process the control tolerates a very high rate of ambient light.

During the operation of the hob control it is continuously adopting and recalibrating towards the change in the ambient conditions.



**The touch control has a sensor which protects against overheating. When responding to this sensor, the relevant burner will be deactivated. For information on explanations or error messages,**

**please see chart. In the event of the non-stop activation of a button (longer than 10 seconds), the entire control system will be deactivated and a permanent signal will sound.**

# 5 Care and Maintenance

## Ceramic hob care

The ceramic glass surface is tough in everyday use and its flat surface makes it easy to clean but please follow the following precautions.

- **Immediately switch off the appliance from the mains if a crack is detected on the ceramic glass surface.**
- **Keep children away from hot surfaces.**
- In order to avoid hob soilage, make sure the bottom of the utensils and the hob surface are clean and dry before use.
- Do not use the surface for food preparation eg cutting bread or slicing vegetables and fruit.
- Do not use the surface for storing or any other non-cooking purpose.
- The scratching or dropping of sharp cornered pots onto the surface may cause damage.
- Do not place any material on the surface, such as plastic, aluminium, etc.
- Any such material that may have melted onto the surface should immediately be removed with a hob scraper.
- Never use a dishcloth or sponge to clean the ceramic hob as these may leave a layer of soiled detergent on the hob which will burn and discolour the next time the hob is used.
- Avoid heating up empty enamel pots.
- Splashes may damage the ceramic surface and can cause fire.

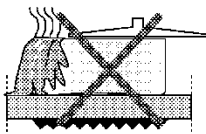

## Saucepan types

### Pan choice

In choosing pans, look for pan handles that can be held easily and will stay cool. Avoid pans that are unstable and easily tipped. Pans that are too heavy to move easily when filled can also be a hazard. Only use flat bottomed pots or pans.

### Pan size

For maximum efficiency and safety, use the recommended pan sizes for each burner.

- Use pans which have sufficient capacity for the amount of food being cooked so they don't boil over and cause unnecessary cleaning.
- Do not place lids on the burners.

Always position pans centrally over the burners. When transferring pans from one burner to another always lift the pans do not slide them.

- Do not use aluminum-bottomed pots. (This results in the deterioration of the ceramic glass surface).
- Use steel or heat-resistant glass pots. Do not use pots made from materials such as "boron glass", or "Pyrex", which are generally oven-type containers.

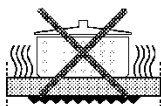
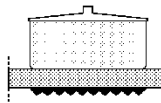
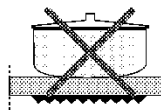

- Do not use pots that have concave or convex bottoms.
- Optimum efficiency is achieved by using pans that match the diameters of the elements
- If the pan is too small energy is wasted.

## Deep fat frying



- Never fill the pan more than the one-third full of fat or oil.
- Never leave unattended during heating or cooking.
- Do not fry too much food at the same time especially frozen food. This only lowers the temperature of the oil or fat too much resulting in greasy food.
- Always dry food thoroughly before frying and lower it slowly into the hot oil or fat. Frozen foods in particular will cause frothing and spitting if added too quickly.
- Never heat fat or fry with a lid on the pan.
- Keep the outside of the pan clean and free from streaks of oil or fat.

## In the event of a chip pan or other pan fire

1. Turn off the cooker.
2. Smother flames with a fire blanket or damp cloth.  
Burns and injuries are caused almost invariably by picking up the burning pan and rushing outside with it.



**Do not use water on the fire.  
Leave the pan to cool for at least 30 minutes.**

## 6 Cleaning

### Turn OFF at the mains before cleaning.

- Before switching on again ensure that all controls are in the OFF position.
- **Make sure the hob is sufficiently cool before you start cleaning.**
- Never mix different cleaning products as different active ingredients may react with unforeseen results.

### powders, detergents or bleach-based cleaning agents as these will damage the surface.

- You can use a ceramic hob scraper (available through Hob Brite and good local stores) to remove spilled food remains and stubborn marks from the surface.

### Exterior

Use a damp cloth to clean the outside. Never use any sharp instruments, abrasive household cleaner, or detergents for cleaning. For hard stains use suitable washing liquid.

### Ceramic hob

Clean daily to avoid soilage being burnt on.

1. Always rinse off fully with a clean cloth wrung out in clean water (as residue could damage the ceramic glass surface next time the hob is used).
  2. Wipe the surface dry with a soft cloth.
- **Do not use steel wool, abrasive**

- **Sugar-based food such as custard and syrup should immediately be scraped off without waiting for the surface to cool down. Otherwise the hob may be permanently damaged.**
- Cleaning material that is suitable for ceramic hobs may damage other parts of your cooker, so take care with surrounding parts.
- Do not use any steam or spray cleaners for cleaning the device.

### Over time...

- Slight discolouration of liners and other surfaces may occur in time. This does not affect the functioning of the appliance.
- Discolourations and marks that occur on the ceramic hob are normal and not a fault.



### Caution hob

Please keep children away from the hob scraper store securely.

### Suitable cleaning and care agents with a protective effect are, for example:

The application of materials with a protective effect is recommended. The film that is produced protects the hob to a great extent from stubborn dirt stains and décor damages.

Crusts from overcooked milk and non-sugar-containing foods can be removed in a warm as well as cool state.

**Recommended for this is a razor blade scraper** which can be purchased at a speciality store. Hold the scraper at a low angle in order to avoid scratches. In no case should crusts be scratched off with serrated edge knives, steel wool or the like.

Remove calcium stains (yellow staining) with small amounts of decalcifying agents such as Durgol, vinegar or lemon juice. Apply agent with a sponge and, in the event of heavier soiling, let it work in for a longer period of time. Afterwards, wash off hob with water.

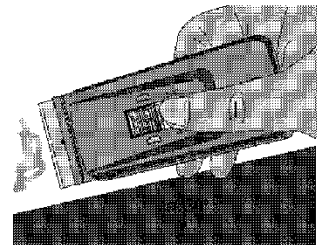
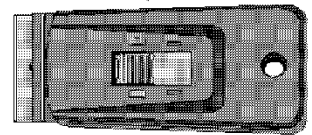
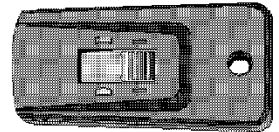

## 7 Trouble shooting

---

### If the hob does not work



If the appliance does not operate check whether:

- The power is on.
- The fuse has blown/circuit breaker has tripped/main distribution switch has been turned off.

If the appliance is still not operating after the above checks, please contact with your customer service.

Please ensure that the above checks have been made as a charge will be made if no fault is found.

## 8 Future transportation

---

Keep the original carton and other packaging material in a safe place. Transport the hob in its original carton. Follow the instructions that are printed on the carton.

### If you do not have the original carton

Secure the caps and Pan supports by adhesivetape.

## 9 Warranty terms and conditions

---

Dear Customer,  
We hope that these owner instructions have answered all of your questions. If this is not the case, please inform us at the telephone number.

If a problem should crop up with your appliance, it is vital that you contact us directly in order to receive help or tips from our team along with original replacement parts with a manufacturer's warranty. Before you call us, you must look up the serial number of the appliance. This is stated on the sticker located on the appliance.

Nonetheless, before you contact us, you should check that all directions contained in these instructions have been followed.

### Performance characteristics when in use

- It is normal for the metal parts to produce noise when in use, this is due to expansion and contraction.
- If, whilst cooking, steam produced comes in to contact with cool surface's on the outside of the appliance, it will condense and produce water droplets. This is quite normal and is not a fault.

Pack the oven in bubble wrap or thick cardboard and tape it securely in order to prevent damage during transportation. The hob must be transported upright. Do not place other items on the top of the cooker.

Any services falling outside of the scope of the warranty will be invoiced.

The statutory warranty provisions cover your right to recourse. It allows the trader's warranty provision obligation to remain unaffected. This trader must be your first contact partner.

**The date of your sales receipt is decisive for the warranty period.**