



*Built-in hob
Induction*

01 639 11

Contents

1. Technical Specifications.....02

2. Safety warnings03

3. Preparation and installation06

Using the assembly clamp.....	07
Electrical Connection.....	08

4. Operating the Hob.....09

Control Elements and Display	09
Turn on the hob.....	10
Select hotplates.....	10
Using the induction hotplates safely and efficiently	11
Automatic Cooking and High Power (Booster).....	13
Turning the hob off	13
Key lock	14
Child lock	14
Timer function.....	15
Noises.....	16
Sensor calibration and Error Messages.....	16

5. Care and Maintenance.....17

Ceramic hob care	17
Deep fat frying	18

6. Cleaning19

7. Trouble shooting20

8. Future transportation21

1 Technical Specifications

! This product has been designed particularly for household usage.

1. Ceramic hotplate
2. Assembly clamp
3. Lower case
4. Ceramic surface

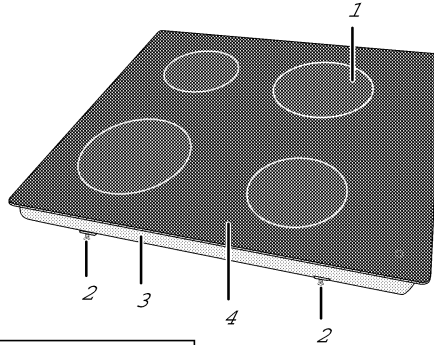

External dimensions	60 cm
Width	580 mm
Depth	510 mm
Height	55 mm
Dimensions of installation setting	
(*) Width	560 mm
Depth	490 mm
Supply voltage	220 - 240 V ~ / 380 - 415 V ~ 50Hz

• The graphics and figures are for illustration purposes only. The actual view may be differ.

- 1- Ø 180 - 1800 W / 2500 W
- 2- Ø 145 - 1400 W / 1800 W
- 3- Ø 210 - 2200 W / 3200 W
- 4- Ø 280 - 2400 W / 3600 W

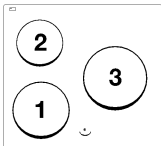
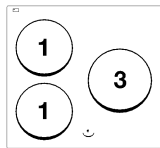
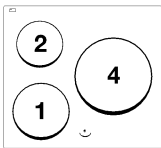
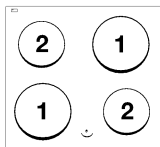
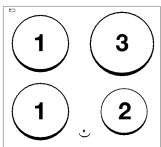

Technical specifications are subject to alteration without prior notification in order to improve the product quality.

Figures included in the manual are for schematic purpose only and may not match exactly with your product. Markings on the product or the values stated in other documents supplied with the product are values obtained under laboratory conditions as per relevant standards. These values may vary according to the usage of the product and ambient conditions.

2 Safety warnings

Look after yourself, family and friends



Look after yourself, family and friends

- **This appliance is not intended for use by persons (including children)**

with reduced physical, sensory or mental capabilities, or lack of experience and knowledge, unless they have been given supervision or instruction concerning use of appliance by a person responsible for their safety.

Children should be supervised to ensure that they do not play with the appliance.

- To make your product ready for use, first prepare the place it will be installed.
- Installation and electrical connections of the appliance may only be made according to the given instructions. Have the required processes performed by a licensed installer/electrician. Then call your Authorized Service.
- If the appliance is to be placed above a cupboard, than a barrier is to be installed. For this, please refer to installation instructions.
- During use surfaces get hot. Don't touch hot surfaces during use.
- Don't store items above the appliance that children may try to reach.
- Close supervision while cooking is essential at all times.
- Check all controls on the appliance are switched off after use.
- When deep-frying, the appliance should be supervised as overheated fats and oils can catch flame easily. Never attempt to extinguish burning oil or fat with water (risk of explosion!). Smother a fire with wet towels and keep doors and windows closed!
- Ensure that the handles of pans and pots do not catch fire or break, or they are not left out of the boundaries of the hob in a level where children can reach.

- Vapor pressure that arise as a result of the humidity between the hob surface and the pan can cause the pan slip or bounce. Therefore, make sure that the bottom of the pan and the hob surface are always dry.

Important for asthmatic sufferers

- It is normal that some smoke and odor may arise during the first usage because of the protective coatings. In this case, ventilate the room thoroughly and avoid inhaling the fume that arises.



Since the induction hob creates a magnetic field, it can cause harmful effects for people who use medical devices such as pacemaker or insulin pump.

Look after your appliance and home



- Clean your appliance regularly, ideally after each use. Always turn off the mains electricity supply and allow the appliance to cool first.
- Spillage should be dealt with as soon as it occurs, taking due care as the appliance surface may be hot. Any spillage left on the surface after cooking should be cleaned off before the appliance is switched on again to prevent baking on.
- Don't use bleaching products, harsh abrasives or chemical cleaners for cleaning.
- **Do not use a steam cleaner with to clean this appliance.**
- Ensure that no flammable materials are adjacent to the appliance as the sides become hot during use.
- Don't place flammable or plastic items on or near the appliance, and never place wet cloths etc. on the appliance to dry.

- Don't heat up unopened food containers as pressure can build up causing the container to burst.
- The surfaces of the stainless steel model appliances which are close to the burners may change colour because of the excessive heat in the course of time.
- Lower electrical hotplates of your hob are equipped with advances **"Induction"** technology. You must use your time and money saving Induction hob with **pans that are suitable for Induction cooking** (read the section on pan choice); otherwise, your appliance will not operate.

Important Safety Information



This appliance is in accordance with the recognized state of the art and the relevant safety provisions. However, proper handling of the appliance is a must in order to prevent damages and accidents. Along with the following information, please take note of further information contained in the text.

WARNING: Immediately switch off the appliance from the mains to avoid the possibility of an electric shock when a crack occurs on the ceramic glass surface due to any mechanical impact. You should refer to your authorized service in such a case.

- No alterations or repair attempts, in particular using tools (screwdrivers, etc.) may be undertaken to or on the appliance. Qualified experts who have been specially trained for this appliance may only perform repairs, in particular to electrical supply parts. Improper repairs may lead to serious accidents, damages and breakdowns. In the event of a breakdown of the appliance, (before contacting our customer service department), please review the information contained under "Warranty terms". Please call our customer services when required.

Natural ventilation is important for the correct functioning of the appliance and your own safety.

Prolonged intensive use of the appliance may call for additional ventilation such as opening a window, or the use of permanent fixed mechanical ventilation system such as an extractor fan or cooker hood that ventilates to the outside.

- **Always refer servicing to a qualified appliance service engineer.**

How to use:

- The glass ceramic hob may only be used for the preparation of food items in the domestic household. In the event that the appliance is misused for another purpose or improperly handled, no liability can be assumed for possible damages.
- Do not use the hob to heat the room.
- As soon as a functional disturbance is detected or if, e.g. due to extreme mechanical effects, cracks appear on the surface of the glass ceramic plate, the device must be put out of operation immediately: turn off the device and disconnect it from the electrical mains network (loosen fuses or turn off automatic switches).
- Connection cables of electrical devices should not be exposed to hot cooking zones or the cookware. Otherwise, the electrical insulation may become damaged.

How to avoid damages to your glass ceramic hob

The glass ceramic surface is non-sensitive to heat (up to 650°C) and temperature fluctuations as well as being break-proof and scratch-resistant to a certain degree.

Nonetheless, please observe the following information in order to prevent damages:

- In no event should you pour cold water over the hot burners.
- Do not climb onto the glass ceramic plate.
- A sudden stress could become critical, e.g. during the impact of a saltshaker. Therefore, it is best that you do not store such items above the hob.
- Before each use, you should ensure that the base of the cookware as well as the surfaces of the cooking zones are clean and dry.
- Always lift but do not drag cookware in order to prevent scratching of the ceramic glass surface and wear and tear to the décor.
- Avoid peeling vegetables upon the hob surface. Grains of sand falling from the vegetables can scratch the glass ceramic plate.
- Do not use the hob as a storage surface; in particular, do not lay any flammable materials, cartons or plastic packages upon it. Objects made of pewter, zinc or aluminum (also aluminum foils or empty coffeepots) could melt on hot cooking fields and cause damages.
- Take care that no sugar-containing foods or juices come into contact with hot cooking zones. The surface of the ceramic glass could be stained as a result. Remove overflows immediately, even while still in a hot state.
- Do not place hot pots or pans on the frame of the burner.
- When cleaning, care should be taken that no water penetrates the appliance, as penetrating water could cause damages. Therefore, you should only use moist cloths. Never squirt water onto the appliance and refrain from using steam cleaners.

Pertaining to Disposal:

- Please separate the packaging materials for recycling and dispose of it at a public rubbish collection location. Packaging materials are not toys for children.
- Permanently connected devices (without plug) must be disconnected from the mains network before removal by a licensed electrician.
- Make the device non-functional before disposal: Cut off mains cable (after unplugging) or any existing loose connection cables on the device.
- Make sure that the appliance is disposed of properly.

Food hygiene

- Ensure meat and poultry is thoroughly defrosted before cooking.
- Check food is thoroughly cooked and is piping hot.

3 Preparation and installation

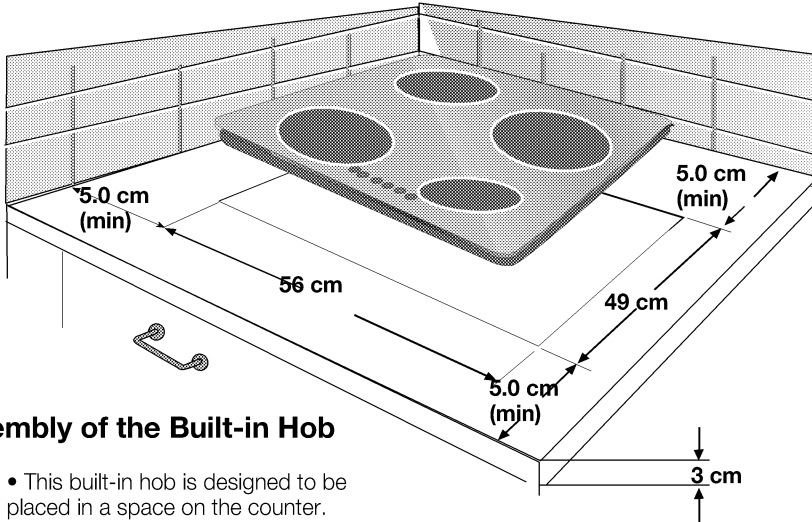

Assembly of the Built-in Hob



• This built-in hob is designed to be placed in a space on the counter. Assembly may only be performed by a trained professional.

- The electrical connections of the appliance to the mains network should be made by a licensed electrician. Thereby, the local safety provisions as well as the technical connection provisions of the local electrical supply company must be observed.
- An all-pole separator with a contact opening of at least 3 mm must be built into the house installation (screw-retaining devices, earthed conductor switch, main switch).
- The distance from the high side walls to the side hollow corner must amount to at least 5 cm.
- If an oven is going to be fitted underneath the hob, then the oven must have a cooling fan.
- Enough clearance should be provided between the bottom side of the induction hob and the built-in oven or furniture to be placed underneath the product in order to allow for adequate air to cool the induction hob. Hence, direction of the hot air towards cooling unit shall be prevented. You must avoid allowing for high temperatures to be built up in the area under the hob as a result of placing an oven without ventilation function underneath the induction hob.

Attention: When installing the hob onto a cupboard, ensure that at least a 55-mm distance is left between the (A) surface of the cupboard and the lower surface of the hob. If installing above an underbench oven this is not required.

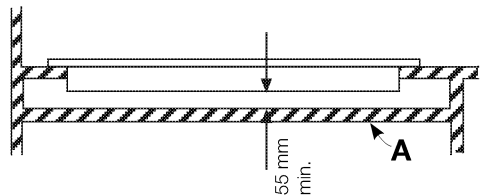

If the underside of the appliance is touchable because of fitting it above a drawer, then this section must be covered by a wooden plate.

If there is an oven below;

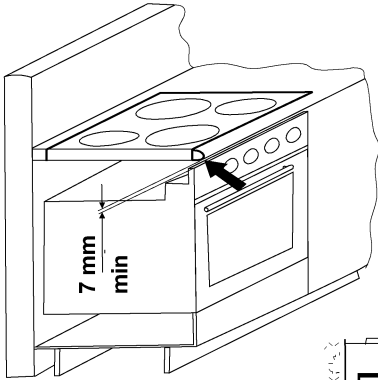

A ventilation opening of min. 180 cm² should be provided at the rear side of the furniture.

If there is a board below;

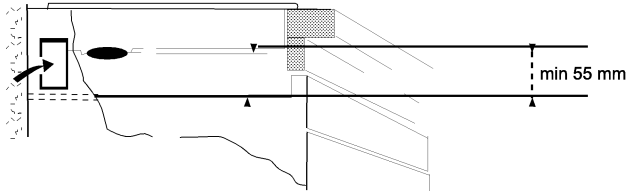
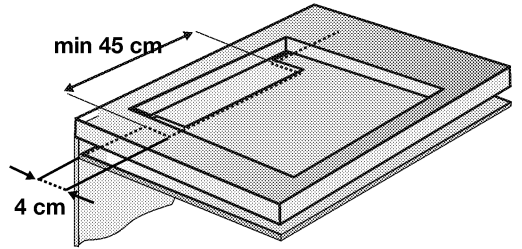

During installation of your induction hob, special care should be paid to place the product parallel to the installation surface. Furthermore, leaking of any kind of liquid between the product and the counter must be prevented by applying the sealing gasket under the hob as described above.

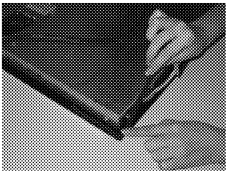
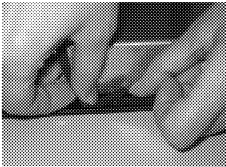

1. Prepare the worktop as shown.
2. Remove the sealing gasket from the packaging.
3. The sealing gasket provided in the package must be affixed around the glass frame on the lower surface as shown in the figure, during installation of your hob.
4. Center the appliance in the counter.
5. Tighten the screws of the springs located on the base of the appliance to secure the appliance in position.

Using the assembly clamp

Installation to your hob must be performed with the supplied assembly clamp as described in Figure 1. An assembly clamp must be installed to the points indicated in the Figure 2, which shows the bottom view of the hob.

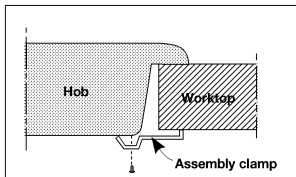

Figure 1

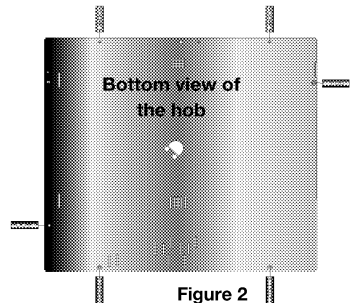

Figure 2

Electrical Connection



- Do not connect the appliance to the electricity supply until all packing and transit protectors have been removed.

Before your appliance is connected to the mains electricity supply, check to ensure that the voltage and frequency shown on the rating label corresponds with your power supply.

- Installation and electrical connections of the appliance may only be made according to the given instructions. Have the required processes performed by a licensed installer/electrician. Then call your Authorized Service.

Operating power of your product is 220 - 240 V ~ / 380 - 415 V ~ 50Hz. In single-phase operation, your hob's current drawing rate is maximum 32 Amperes and maximum 2x16A during 2-phase operations.

Have the compliance of the fuse and electrical installation of your home checked by a licenced electrician and have them approved as to their suitability for your product.

- Have the grounding installation connected by a licensed electrician.

Warning!

This appliance must be earthed.

- The appliance must be connected via the supplied original cable or by a cable equivalent to h05RRF 5G1,5mm² cable.
 - A switch capable to cut the power to all poles on the product, having a 3mm-gap between its contacts must be used with the product. This switch should be located to an accessible place.
 - The power cable should be routed away from the appliance.
 - If the power cable is damaged, it must be replaced only by the authorized service.
- The cable length should be 2 m. max for isolation safety.**
- Our firm shall assume no responsibility in case of damages arising from usage without observing the instructions given above.

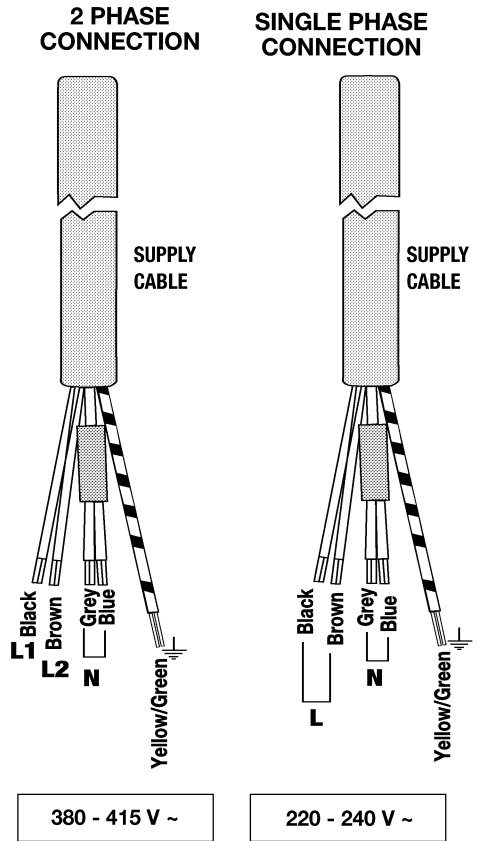

Have a licenced electrician connect the power cable's

- brown wire to the live phase,
- black wire to the live phase (to the other live phase if available),



- blue wire to neutral line,
- grey wire to neutral line,
- green/yellow wire to the grounding line.

4 Operating the Hob

Control Elements and Displays

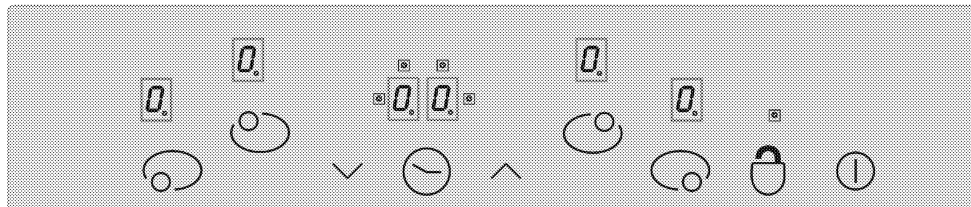

Features

 Main button - ON/OFF Key

 Keylock

 Heat setting/Timer increase

 Heat setting/Timer decrease

 * Activate/deactivate timer

 Hotplate (cooking zone)
Selection controls



 → Decimal Point

 * Timer display (4 LED assigned for 4 different hotplate)

Note:

- This appliance is controlled via the touch control unit. If your touch control unit has a timer, each operation is confirmed with an audio signal.
- Always keep the control panels clean and dry. Moisture and dirt may cause malfunctioning.

• The graphics and figures are for illustration purposes only. The actual view or functions may differ.

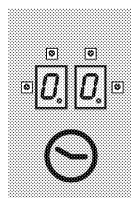

(* If your hob is equipped with timer.

Turning the hob on

Touch the “**I**” key in the control panel at least 1 second. Hotplate displays light up. “**0**” and all the relevant decimal points flash in all hotplate displays. The hob is ready for use. You can select different hotplates within next 10 seconds.

The hob will automatically turn off if there is no operation within 10 seconds.

Selecting the Hotplates (Cooking Zone)

Put your pan suitable for induction-cooking (pan with magnetic bottom, see page 12, “suitable pan choice”) onto the related hotplate.

1. Turn on the hob.
2. Touch the relevant hotplate selection control to turn on the desired hotplate. After the hotplate is selected, “**0**” decimal point stops flashing on the related hotplate display and becomes solid.
3. Set the heat level between “**1**” and “**9**” or “**9**” or “**1**” by touching “**^**” or “**v**” keys.

The “**^**” or “**v**” keys are equipped with a repeat function. If you touch one of the key longer time, heat level will continually be increased or reduced at every 0,4 second.

If you begin with “**^**” key, “**1**” will appear on the display. If you begin with “**v**” key, “**A**” and “**9**” will flash on the display with a period of half seconds. This indicates that the **Automatic Cooking** is running. At the end of the preset time for **Automatic Cooking** by the manufacturer, selected hotplate stops the **Automatic Cooking** function and starts operating at the level that had been set while the Automatic Cooking function was selected.

4. To switch your oven to high power position, increase the level up to 9 with “**^**” key and then press “**^**” key again. Thus, it will switch into the high power “**P**” (**Boost**) position

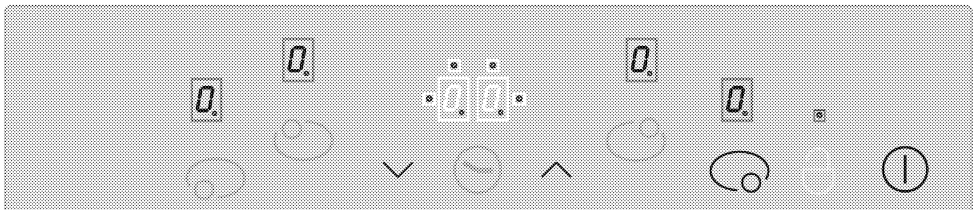

If “**0**” is flashing;

- Your pan is not suitable for induction cooking.
- There is nothing on the selected hotplate.
- Bottom diameter of the pan is small for the hotplate.



You can not operate both of the hotplates in either right or left hotplate group in the boost position at the same time.

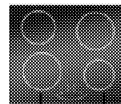

Left Hotplates Right Hotplates

Maximum total power drawn by the right and left hotplates of your hob is 3600 Watts.

Example: If one of the hotplates in the same direction (right or left) is set to level “**P**”, then the system allows you to adjust the other hotplate up to level 8 without changing the setting of the first hotplate.

Using the induction hotplates safely and efficiently

Operating principle: Because of its operating principle, induction hob directly heats the pan. Therefore, it has many advantages compared to other types of hobs. It is more efficient and the surface of the hob is cooler.

Your induction hob is equipped with superior safety systems that will allow you to use your appliance with maximum safety.

The hob control has a limitation of the operating time. If one or more hotplates are inadvertently not switched off, hotplate will be automatically deactivated after a certain amount of time. (see following Table-1).

Meantime; If a timer was associated with the hotplate, than a “00” will be displayed on the timer display for 10 second. The limit of the operating time depends on the temperature setting selected by the manufacturer.

After the hotplate is switched off automatically as described above it becomes ready to be operated by the user again. Maximum operating time is applied also for this heat setting.

Important: Your hob contains zones of Ø 145, Ø180, Ø 210 and Ø 280 which have induction features. Thanks to the induction feature, each hotplate automatically detects the diameter of the pan put on it. **“Energy is created only at places where the bottom of the pan touches”** and thus, energy is consumed at the minimum level.

Cooking Level	Time of Operation - (hour)
0	0
1	6
2	6
3	5
4	5
5	4
6	1,5
7	1,5
8	1,5
9	0,5
P (boost) - Quick Cooking (booster)	10 minutes (*)

Table-1: Preset operating times when you forget to turn off the hob

(*) 10 minutes later, hotplate decreases to level 9.

Over Heating Protection

There are some sensors inside your hob in order to provide over heating protection. Below responses may arise in an over heating condition:

- The running hotplate can be turned off.
- Selected level can be decreased. (But it is not indicated on the display.)

Safety system against overflow

Your hob is equipped with a safety system against overflowing. If any overflowing occurs on the control panel for any reason, the system automatically cuts the power connection to turn your hob off. Meantime, “F” appears on the touch -display.

Residual heat indicator

The induction hob may get hot after the cooking process because of the pan left on the hotplate. Until the glass table on the hob section drops down to a safe temperature, “H” will be displayed on the control panel. “Do not touch the related sections until “H” disappears.



Temperature display does not light up and warn the user anymore during a power failure.

Sensitive power setting

Because of its operating principle, induction hob responds to the commands immediately. They change the power settings in a quick way. Thus, you may prevent a cooking dish (water, milk) from overflowing by turning off the appliance.

Pan choice:

You may only use pans suitable for induction cooking on your induction hobs.

Pan test:

You can use the following methods to test if your pan is compatible with the induction hob.

1. If your pan's bottom holds a magnet, it is suitable.
 2. If the power grade (U) does not flash when you place your pan on the induction zone and operate the zone, it is suitable.
- On your induction hob, you can use steel, teflon or special magnetic bottom aluminum pans, compatibilities of which are indicated on their labels. Glass, ceramic and earthenware as well as non-magnetic stainless steel pans with copper or aluminum bottoms cannot be used.

Pan recognition-focusing system

In an induction cooking, energy is given only to the bottom of the pans and pots on the related hotplate. The diameter of the pan is instantly recognized by the induction system and only this zone is heated automatically. If the cooking pan is lifted from the hotplate during cooking, then cooking is interrupted. Selected hotplate level and "U" flash alternatively.

Safe usage:

Preheat the hotplate at level 3 or 4 on which you will use non-oil or less-oil covered non-sticking pan (teflon type). Never use at level 8,9 and "P" as this will damage your pan.
Do not put metal objects such as forks, knives or pan covers on your hob as they will get hot. Never use aluminum folio for cooking. Never place products wrapped with aluminum folio on the electrical hotplate.

Caution!

- * If there an oven underneath your hob and it is operating, then the sensors on the hob may decrease the level or turn off the hob.
- * When using the hob, do not leave objects of magnetic characteristics (credit cards, cassettes, etc.) on it.

Using cooking zones according to the pan

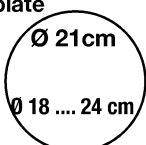
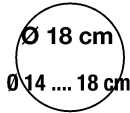
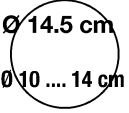
Large cooking zone This cooking zone: <ul style="list-style-type: none">- Automatically fits to the pan.- Distributes the optimum power.- Provides excellent heat distribution; you can prepare undercooked or overcooked large crepes, large fish and etc.	Normal cooking zone	Small cooking zone Slow cooking (sauces, creams) You can prepare small amounts of or personal portions
Large hotplate  Ø 21 cm Ø 18 24 cm	Middle hotplate  Ø 18 cm Ø 14 18 cm	Small hotplate  Ø 14.5 cm Ø 10 14 cm

Automatic Cooking and High Power (Booster)

Automatic cooking function makes cooking easier. If the Automatic Cooking is active, the hotplate will be operated with maximum power for a period of time (see Table -2). Quick heating time depends on the selected heat level. This is indicated through a flashing “A” alternating with the heat setting value (e.g. half second “A” and half second “9”) in the hotplate display. At the end of the quick heating time, hob will return to the normal heating mode for the selected level and “A” will disappear.

All hotplates are equipped with Quick Heating function.

The below table contains the automatic heating times for different heating levels.

Cooking Level	Quick Heating Time of Operation - (second)
1	10
2	30
3	47
4	65
5	85
6	25
7	35
8	45
9	10

Table -2: Quick Heating Times in Automatic Cooking

Turning On the Automatic Cooking Feature:

1. Turn on the hob.
2. Select desired hotplate by touching hotplate selection keys.
3. “√” key to switch the heat value of the hotplate to the desired level. “9” and “A” will be displayed on the screen respectively. This means heat setting value “9” and Quick Heating feature is active now.
4. Quick heating function of the level to be selected is determined with “^” or “√” keys.
5. The specified Quick Heating function operates for the period according to the cooking level in table 2 and reverts back to its level after the time elapses. (For example, this period is 25 minutes for level 6)

Turning Off the Automatic Cooking Feature:

- The Automatic Cooking function can be turned off early by decreasing the heat setting to “0”.
- Automatic Cooking is not active anymore when the period in table 2 is over.

High Power (Booster)

You can use high power level to heat your hob faster. But, it is not recommended to cook in this position for too long.

Select the relevant hotplate to be operated and place the suitable pan. Increase its level up to 9 and then revert it back to P position by pressing “^” key. Due to temperature, your hob will only be allowed to operate for maximum 10 minutes and the hotplate of the hob selected for booster function will automatically decrease to level 9.

Turning the hob off

If the main switch “ⓘ” is pressed more than 2 sec, the hob is turned off. If the relevant hotplate is still hot when the hob is turned off, then “H” will light in the display continuously.

Turning Off The Individual Hotplates:

A selected hotplate can be turned off in 3 different ways:



1. Simultaneous operation of the “^” and “√” keys

The desired hotplate must be chosen with the hotplate selection “Ⓒ” key. For example (“9”) Decimal point becomes solid on the display of the hotplate. The “^” and “√” keys must be touched at the same time to turn off the hotplate.

2. Reduction of the heat setting to “0” by operating the “√” key of the desired hotplate

3. Use of timer turn off function for desired hotplate (If timer function is available)

Key Lock

Touch “” key more than 2 seconds to lock Touch Control. The operation will be confirmed with an audio signal. Afterwards “” LED lights up continuously and all hotplates are locked.

If the hotplates are locked, only the main switch “” can be operated.

If you turn off the hob when keys are locked, key lock will be still active after you restart the hob again. In order to operate the hob in a such condition, key lock should be disabled.

Keylock is cancelled in power failures.

Cancelling the key lock:

If the “” key is touched 2 seconds, the hotplate is unlocked. The operation will be confirmed with an audio signal.

Afterwards the “” LED disappears. Now, the touch control is unlocked and can be operated as usual.

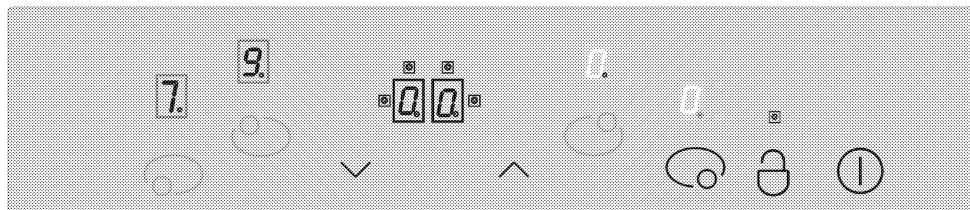





Lock or unlock the Touch control in operation mode by touching the “” key.

Child Lock





You can take the hob under protection in order to prevent children from turning on the hotplates. Child Lock functionality is foreseen to lock the touch control unit in a complicated multi-step process.

Child Lock can only be activated and deactivated in standby mode.

How to lock the module:

1. Turn on the hob using main switch “”.
2. Touch “” and “” keys simultaneously at least for 2 seconds and wait for audio confirmation signal from the panel.
3. Then touch “” key once again. Child lock function becomes active with a second confirmation signal and “” appears on the display of all hotplates

Cancelling the child lock:

1. Turn on the hob using main switch “”.
2. Touch “” and “” keys simultaneously at least for 2 seconds and wait for audio confirmation signal from the panel.
3. Then touch “” key once again. Child lock becomes deactivated with a second confirmation signal

“” appears on the hotplate displays as long as the lock is open.

“” will disappear immediately after successful unlocking.

Timer Function *



This feature facilitates the cooking for you. You do not need to be permanently attend the hob during the cooking procedure; the hotplate is automatically turned off at the end of the selected time.

* The timer provides following features:

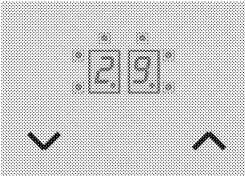
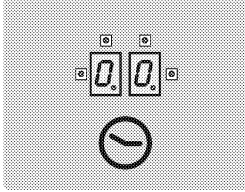
Touch control can operate maximum 4 assigned hotplates at the same time. All timers can be used only in the operation mode of the hotplate which they are associated with.











Hotplate timer:

1. First turn on the hob and activate the desired hotplate. (hotplate can be at a level between 1 and 9 or at high power (p) position.)
2. Activate the hotplate timer by touching “” key. The timer display will indicate “00.” Thus, hotplate timer is activated.
3. Set the desired time value with “” and “” keys.

Hotplate timers can be set only for activated hotplate.

To set the hob timers:

1. Touch “” key again after activating the first hotplate timer. The control rotates clockwise to the next active hotplate assigned to a timer. The assignment recommendation is indicated by the flashing  led.
2. Set the desired time value with “” and “” keys.
 - Touching the “” key once again further timers can be assigned to other activated hotplates.
 - 10 seconds after setting the timer values of the hotplates, the timer display will revert back to the time that will end first and the LED of the relevant hotplate flashes.
 - The statically on LEDs “” on timer display identify us the running timers.
 - By toggling the “” key you can display the timer values for the hotplate timers. In this step, the LED “” of the hotplate timer in turn flashes.

An audio alarm will be heard when the set alarm time is over. You have to touch any key on touch control panel to stop the buzzer sound.

Cancel Timers :

First, change the position of the “” button to display the timer that needs to be turned off. This timer can be cancelled in two different ways.

- decrement by touching the “” until “00” appears on the timer display.
- touch the “” and “” key simultaneously for half second until “00” is shown in timer display.

Noises

Some sounds may be heard from induction heated hob. Such sounds are normal and a part of cooking with induction. Such sounds;

- may be intensified when the level is in high power position.
- may arise from the structural materials of the pan.
- In low power positions, a regular on-off sound can be heard due to the operating principle.
- Sound can occur while heating an empty pan. Such sound will disappear when you add water or food in it.
- Noise of the fan which is used to cool the electronic system can be heard.

Sensor Calibration and Error messages

The hob control performs an automatic calibration in reference to the sensor-, glass- and ambient conditions after the main voltage is applied. Do not cover the glass area of the sensor during the calibration. In addition, the hob control must not be exposed to strong illumination, like sunlight, strong halogen lights and etc.

Error reason	Display
Ambient light too high	F1
Strong pulsating light (fluorescent tube)	F2
Sensor covered with a bright object	F3
Strongly fluctuating ambient light	F4
Calibration error	AX
Induction hardware error	EX

Table -3: Error codes and source of errors (X= "0...9")

Application Example:

The calibration performs without any problems if the following illumination is present:

Illumination through a light bulb without reflector (100W, opal) in a distance of 70 cm above the glass ceramic hob.

After a successful calibration the function of the hob is also guaranteed even with strong illumination, for example with halogen spot with reflector (50W).

In case of an error, the calibration is repeated until the ambient conditions allow a successful calibration. The operation of the hob control is only possible, if the calibration of all sensors were successfully completed.

After successful finished calibration process the control tolerates a very high rate of ambient light.

During the operation of the hob control, it continuously adopts and recalibrates itself towards the changes in the ambient conditions.



Please see Table 3 for information on explanations related to the error messages that can appear on the touch control display.

- **In the event that the touch control surface is closed for a period longer than 10 seconds, the entire control system will be deactivated and a warning signal will sound. Also "F" flashes on the hotplate display.**
- **If the surface of the touch control is exposed to dense vapour, the entire control system will be deactivated and a warning signal may be given.**
- **Keep the surface of the touch panel clean. Otherwise, malfunctioning may occur.**

5 Care and Maintenance

Ceramic hob care

The ceramic glass surface is tough in everyday use and its flat surface makes it easy to clean but please follow the following precautions.

• **Immediately disconnect the appliance from the mains if a crack is detected on the ceramic glass surface.**

• **Keep children away from hot surfaces.**

• In order to avoid the hobs get soiled, make sure the bottoms of the utensils and the hob surfaces are clean and dry before use.

• Do not use the surfaces for food preparation such as cutting bread or slicing vegetables and fruit.

• Do not use the surface for storing or any other non-cooking purpose.

• Rubbing or dropping sharp edged pots onto the surfaces may cause damage.

• Do not place any material on the surface, such as plastic, aluminum, etc.

Any such material that may have melted on the surface should immediately be removed with a hob scraper.

• Never use a dishcloth or sponge to clean the ceramic hob as these may leave a layer of soiled detergent on the hotplate which will burn and discolor the next time the hob is operated.

• Avoid heating up empty enamel pots.

• Splashes may damage the ceramic surface and can cause fire.

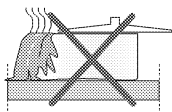

Pan size

For maximum efficiency and safety, use the recommended pan sizes for each hotplate.

- Use pans which have sufficient capacity for the amount of food being cooked so they don't boil over and cause unnecessary cleaning.
- Do not place lids on the burners.

Always position pans centrally over the hotplates. When transferring pans from one hotplate to another, always lift the pans and never slide them.

• Do not use aluminum-bottomed pots. (This results in the deterioration of the ceramic glass surface).

• Use the pans (pots) described in pan choice section. Do not use pots made from materials such as "boron glass", or "Pyrex", which are generally oven-type containers.

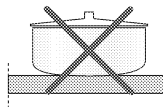
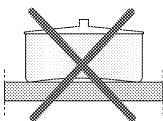

• Do not use pots that have concave or convex bottoms.

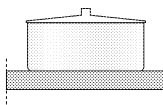

• Optimum efficiency is achieved by using pans that match the diameters of the hotplates.

Deep fat frying



- Never fill the pan more than the one-third full of fat or oil.
- Never leave unattended during heating or cooking.
- Do not fry too much food, particularly the frozen food, at the same time. This only lowers the temperature of the oil and results in foods that absorbed too much oil.
- Always dry food thoroughly before frying and lower it slowly into the hot oil or fat. Frozen foods in particular will cause frothing and spitting if added too quickly.
- Never heat fat or fry with a lid on the pan.

- Keep the outside of the pan clean and free from streaks of oil or fat.
- Oil may catch fire if you use your product for a long time with pans which are not suitable.

In the event a frying pan flames up or other pan catches fire:

1. Switch off the hob
2. Smother flames with a fire blanket or damp cloth.



**Do not use water on the fire.
Leave the pan to cool for at least
30 minutes.**

Almost all burns and injuries in such events are caused invariably by picking up the burning pan and rushing outside with it.

6 Cleaning

Disconnect the appliance from mains before cleaning.

- Before starting to clean the appliance, make sure that all controls are in OFF position.
- **Make sure the hob is sufficiently cool before you start cleaning.**
- Never mix different cleaning products as different active ingredients may react with unforeseen results.

Exterior

Use a damp cloth to clean the exterior of your appliance. Never use any sharp tools, abrasive household cleaners or detergents for cleaning. Use a suitable washing liquid for dried, hard stains.

Glass-ceramic Surface

Clean dirt daily to avoid them being burnt on.

1. Always wipe the surface of the hob fully with a clean cloth wrung out in clean water (as residue could damage the ceramic glass surface next time the hob is used).
 2. Wipe the surface dry with a soft cloth.
- **Do not use steel wool, abrasive powders, detergents or bleach-based cleaning agents as these will damage the surface.**

- You can use a ceramic hob scraper (available at supermarkets) to remove spilled food remains and stubborn marks from the surface.

- **In cleaning surfaces that are stainless, do not use cleaning agents containing acid or chlorine. As you clean, take care to wipe in a single direction with the aid of a soft, soapy cloth and liquid (nonabrasive) detergent.**
- **Sugar-based food such as custard and syrup should immediately be scraped off without waiting for the surface to cool down. Otherwise the hob may be permanently damaged.**

- Cleaning material that is suitable for ceramic hobs may damage other parts of your appliance, so take care with surrounding parts.

- Do not use any steam or spray cleaners for cleaning the device.

Over time...

- Slight discoloration on coatings and on other surfaces may occur in time. This does not affect the operation of the appliance.
- Discolorations and marks that occur on the glass ceramic surface are normal and not a fault.



Warnings related to hob

Please store the hob scraper away from the reach of children.

7 Troubleshooting

If the hob does not work



If the appliance does not operate check the following:

- There may be a power failure.
- The fuse may be blown/circuit breaker may be tripped/main distribution switch may be turned off.
- Over heating production may exist. Wait until your hob cools down.
- The pan may not be suitable. Check your pan.

If the hotplate displays **U** continuously;

- There may not be a pan on the active hotplate.
- Your pan may not be compatible with induction hob.
- Pan may not be centered correctly on the hotplate or the bottom of the pan is not wide enough for the selected hotplate.
- Pan or the hotplate may be too hot; wait until it cools down.

If the selected hotplate turns off suddenly;

- Time of operation of the selected hotplate may have elapsed.
- Over heating production may exist. Wait until your hob cools down.
- Something might have touched the touch control.

Pan does not heat although the hotplate is turned on;

- Your pan may not be compatible with induction hob.
- The bottom of the pan may not be wide enough for the selected hotplate.
- Pan may not be centered correctly on the hotplate.

If **U** does not appear on the active hotplate display although there is no pan on it;

- If the hob is supplied through two phases, one of the phases may have failed. If none of the above conditions exist, then switch off and on your hob by means of the touch-control or disconnect the hob from the power supply and connect again after a few seconds.

If the cooling fan keeps on working after the hob is turned off;

This is not a failure. It is quite normal. It will continue cooling until the hob comes down to the normal temperature.

Please ensure that the above checks have been made since service charges may apply if no fault is found.

If the appliance is still not operating after all checks are made, please contact with your customer services.

Performance characteristics when in use

- It is normal for the metal parts to produce noise when in use due to expansion and contraction.
- If, whilst cooking, the produced steam comes into contact with cool surfaces on the outside of the appliance, it will condense and produce water droplets. This is quite normal and is not a fault.

8 Future transportation

Keep the original carton and other packaging material in a safe place. Transport the hob in its original carton. Follow the instructions that are printed on the carton.

If you did not keep the original carton

Secure the caps and Pan supports by adhesive tape.

Pack the oven in bubble wrap or thick cardboard and tape it securely in order to prevent damages during transportation.

The hob must be transported upright. Do not place other items on the top of the cooker.