

CONTENTS

3

5

5

6

7

7

8

9

11

11

11

13

15

16

16

17

18

19

19

19

21

21

23

23

23

23

25

26

27

28

28

29

29

32

32

32

32

33

SET-UP AND SAFETY

CONNECTION/PREPARATION

Connecting the antenna and the mains cable

Inserting batteries in the remote control

OVERVIEW

Connections on the television

Controls on the television

The remote control

SETTINGS

Setting television channels automatically

Changing stored channels

Picture settings

Audio settings

TELEVISION OPERATION

Basic functions

Zapping function

Changing the picture format

TELETEXT MODE

FLOF text and normal text mode

Additional functions

CONVENIENCE FUNCTIONS

Convenience functions with the »Features« menu

USING EXTERNAL DEVICES

DVD player, DVD recorder, video recorder or set-top box

High definition - HD ready

Connecting a DVD player, DVD recorder, video recorder or set-top box

Headphones

Decoder or satellite receiver

Camcorder

PC MONITOR MODE

Connecting a PC

SPECIAL SETTINGS

Setting television channels

INFORMATION

Technical data

Service information for dealers

Environmental note

Troubleshooting

SET-UP AND SAFETY

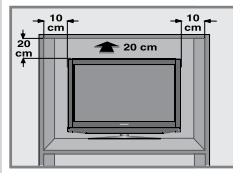

Please note the following information when setting up your television set.

This television set is designed to receive and display video and audio signals.

Any other use is expressly prohibited.

The ideal viewing distance is 5 times the screen diagonal.

External light falling on the screen impairs picture quality.

To assure sufficient ventilation make sure there is enough space around it in the wall unit.

The television set is designed for use in dry rooms. If you do use it in the open, please ensure that it is protected from moisture, such as rain or splashing water. Do not expose the television set to any moisture.

Do not place any vessels such as vases on the television, as they may spill liquid, thus presenting a safety risk.

Place the television set on a solid, level surface. Do not place any objects such as newspapers on the television set or cloth or similar items beneath it.

Do not place the television set close to heating units or in direct sunlight, as this will impair cooling.

Heat build-up can be dangerous and shortens the operating life of the television set. For reasons of safety, have a specialist remove any dirt deposits in the set from time to time.

Do not open the television set under any circumstances. Warranty claims are excluded for damage resulting from improper handling.

Make sure the power cord or the power supply unit (if provided) are not damaged.

The television set may only be operated with the mains cable/adaptor supplied.

Thunderstorms are a danger to all electrical devices. Even if the television set is switched off, it can be damaged by a lightning strike to the mains or the antenna cable. Always disconnect the mains and antenna plugs during a storm.

Clean the screen with a soft, damp cloth. Only use plain water.

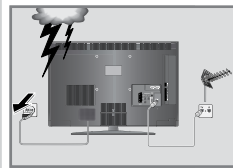
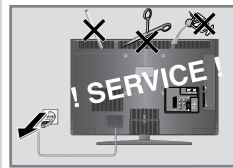
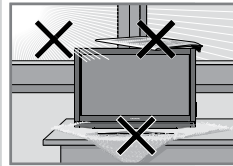
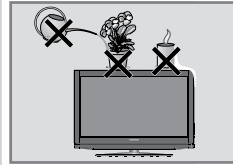

SET-UP AND SAFETY

Please note when deciding where to put the device that furniture surfaces are covered by various types of lacquer and plastic, most of which contain chemical additives. These may cause corrosion to the feet of the device, thus resulting in stains on the surface of the furniture which can be difficult or impossible to remove.

The screen of your LCD television meets the highest quality standards and has been checked for pixel faults.

Despite the great care taken in manufacturing, technological reasons make it impossible to completely discount the possibility that some pixels may be faulty.

Provided they are within the thresholds specified by the DIN norm, pixel faults of this kind cannot be regarded as a defect as defined by the warranty.

Notes:

Do not connect any other equipment while the device is switched on. Switch off the other equipment as well before connecting it.

Only plug the device into the mains socket after you have connected the external devices and the antenna.

Make sure the power plug is freely accessible.

Caution:

If you want to use a wall bracket for your television, make sure you read the assembly instructions for the wall bracket carefully or have your specialist dealer mount it for you.

When buying the wall bracket, make sure that all the fastening points needed on the television are there on the wall bracket and that they are all used when it is mounted.

CONNECTION/PREPARATION _____

Connecting the antenna and the mains cable

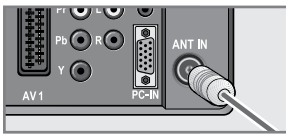
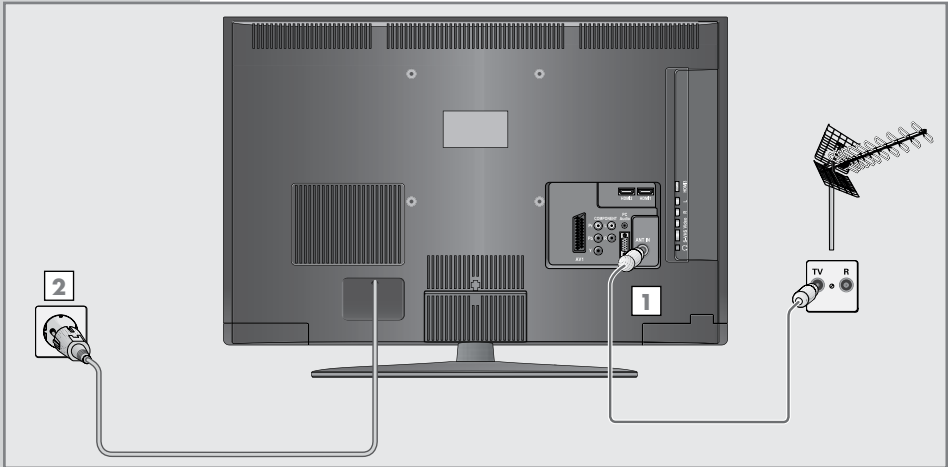

- 1 Plug the antenna cable of the rooftop antenna into the »ANT IN« antenna socket on the television.
- 2 Plug the mains cable into the wall socket.

Note:

Only plug the device into the mains socket after you have connected the external devices and the antenna.

Only connect the television using the power cord supplied to a suitable earthed safety socket.

Do not use an adapter plug or extension lead which does not meet the applicable safety standards. Do not tamper with the power cord.

CONNECTION/PREPARATION _____

Inserting batteries in the remote control

- 1 Open the battery compartment by removing the lid.
- 2 Insert the batteries (3 x 1.5 V micro for example R03 or AAA). Observe the polarity (marked on the base of the battery compartment).
- 3 Close the battery compartment.

Note:

If the television no longer reacts properly to remote control commands, the batteries may be flat. Be sure to remove used batteries.

The manufacturer accepts no liability for damage resulting from used batteries.

Environmental note

Batteries, including those which contain no heavy metal, may not be disposed of with household waste. Please dispose of used batteries in an environmentally sound manner. Find out about the legal regulations which apply in your area.

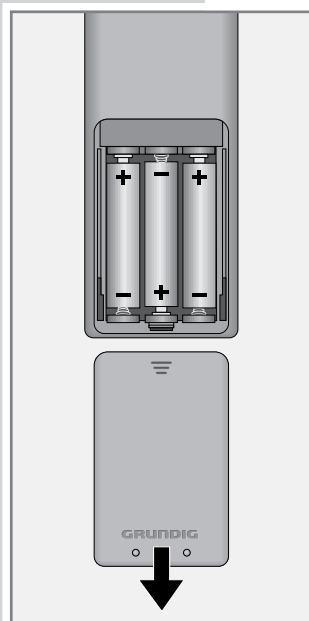

OVERVIEW

Connections on the television

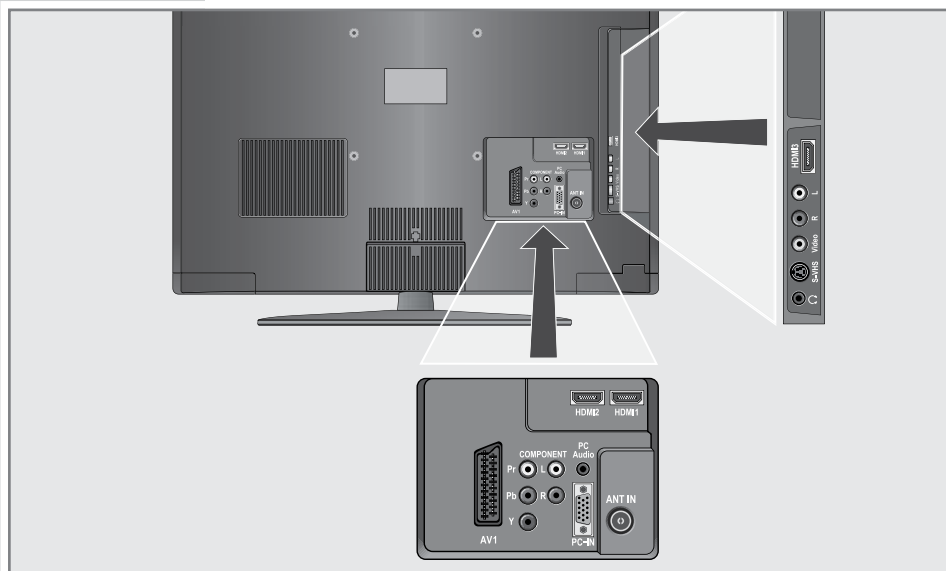

AV1	Euro/AV socket (FBAS signal, RGB signal).
COMPONENT	
Y Pb Pr	Video signal input (YUV signal).
LR	Audio signal input (YUV signal).
PC Audio	Audio signal input for PC.
PC-IN	VGA socket, video signal input for PC.
ANT IN	Antenna socket.
HDMI2	HDMI socket, audio/video signal input (HDMI).
HDMI1	HDMI socket, audio/video signal input (HDMI).
	Headphone connection (3.5 mm jack plug).
S-VHS	Video signal input for S-Video camcorder.
Video	Video signal input for camcorder.
L R	Audio signal input for camcorder.
HDMI3	HDMI socket, audio/video signal input (HDMI).

OVERVIEW

Controls on the television

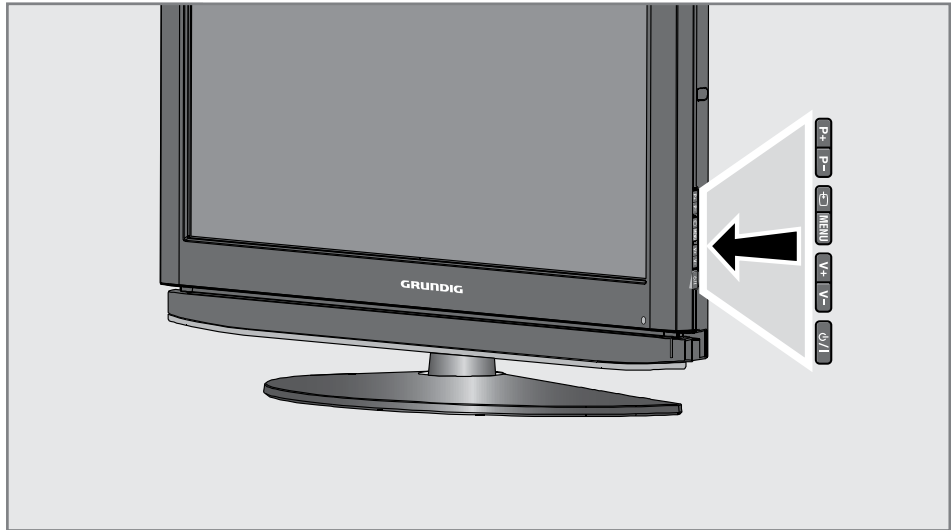

P/I

Switches the television on and back into standby.

The only way to disconnect the television from the mains supply is to pull the plug.

V- V+

Adjust the volume.

Select menu functions.

MENU

Opens the main menu.

Select menu item with »P+« or »P-«.

Activate the function with »V+« or »V-«.

Set the function with »V+« or »V-«.

Switch off the menu with »MENU«.



Opens the pre-selection for AV channels.

Select within the menu with »P+« or »P-«, confirm with »V+« or »V-«.

P- P+

Switch the television on from standby.







Station selection.

Select a function in the menu.

OVERVIEW

The remote control



-  Switches off the television set (stand-by).
- 1...0** Switches the television on from standby mode
Selects channels directly.
- ?** Displays the number and name of a station;
reveals answers in teletext mode.
- PIP** Key has no function.
-  Switches between picture formats.
-  Sound on/off (mute).
- AV** Opens the pre-selection for AV channels.
Then selection with »**V**« or »**^**«.
Switches to double character size in teletext mode.
- i** Opens the menu;
switches the menus back one menu level.
- Z** Zapping function.
- ^ v** Switches the television on from standby;
selects stations step by step;
moves the cursor in the menus up and down.
-  **(OK)** Calls up the channel list;
activates various functions.
- +** Adjusts the volume;
moves the cursor left/right.
- TXT** Switches between teletext and TV modes
- TV-G** Key has no function.
-  Selects various picture settings;
selects a page in teletext mode.
-  Displays the time;
selects a page in teletext mode.
-  Selects a page in teletext mode
- ?** Selects various audio settings;
selects a page in teletext mode.

OVERVIEW



SCAN

Key has no function

PAT

Page stop in teletext mode.

S

Selects subpages in teletext mode.

P

Updates a page in teletext mode.

M

Switches to operation of a GRUNDIG digital receiver, GRUNDIG digital receiver with hard disk (PDR), GRUNDIG DVD player, GRUNDIG DVD recorder or GRUNDIG AV receiver.

Press »M« until the »DR«, »DVD« or »AMP« display lights up.

Then select the one you want.

If you do not press a button within 10 seconds, the remote control returns to television mode (»TV«).

Note:

»DR« has been programmed for operating a GRUNDIG digital receiver (remote control level 1).

»DVD« has been programmed for operating a GRUNDIG DVD player.

»AMP« has been programmed for operating a GRUNDIG AV receiver.

The functions available depend on the model of the device you are using.

Just try it out.

You can change this programming:

Press and hold down »M« and press three number buttons to enter the code:

»1«, »2«, »3« for a GRUNDIG DVD player.

»4«, »5«, »6« for a GRUNDIG DVD recorder.

»1«, »4«, »7« for a GRUNDIG digital receiver (remote control level 1).

»2«, »5«, »8« for a GRUNDIG digital receiver (remote control level 2).

»3«, »6«, »9« for a GRUNDIG digital receiver with a hard disc (PDR).

SETTINGS

Setting television channels automatically

The television set is equipped with an automatic channel search system.

You start the search and can then sort the television channels into your order of preference.

100 preset positions are provided, to which you can assign television channels from the antenna or from the cable connection.

1 Press **⏻**, **»1...0«** or **»V«** or **»^«** to switch on the device from standby mode.

-The **»language«** menu appears when the television is first switched on.

Hint:

If the **»language«** menu does not appear on the screen, then set it in accordance with the chapter on resetting all television channels on page 32.

2 Select language with **»-«** or **»+«** and press **»●«** to confirm.

-The **»COUNTRY SELECTION«** menu appears.

3 Press **»V«** or **»^«**, **»-«** or **»+«** to select the country and **»●«** to confirm.

-The search begins. It may last a few minutes, depending on the number of television stations found.

-After the search the television switches to channel position 1 and the **»PROGRAM TABLE«** menu appears.

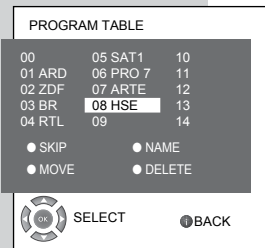
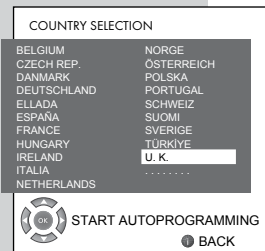
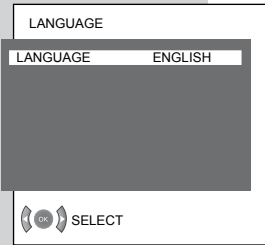

Changing stored channels

You can delete channels that have been stored more than once during the automatic search. You can also store channels in a different preset position, change or enter the name of a channel as well as skip channels.

Deleting channels

1 In the **»PROGRAM TABLE«** menu, select the station to be deleted with **»V«** or **»^«**, **»-«** or **»+«**.

2 Highlight the channel with **»↵«** (blue).

3 Press **»↵«** (blue) to delete the channel.

Note:

To delete other stations, repeat steps 1 and 3.

SETTINGS

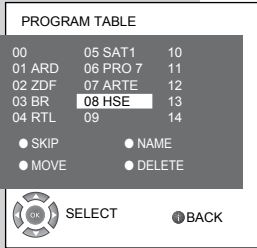

Sorting television channels

- 1 In the »PROGRAM TABLE« menu, select the channel to be moved with »▼« or »▲«, »-« or »+«.
- 2 Highlight the channel with »⊙« (green).
- 3 Select a new channel position by pressing »▼« or »▲«, »-« or »+« and then press »⊙« to confirm.
-All of the channels that follow move up one position.

Note:

To sort the other television channels repeat steps 1 to 3.

Entering the channel names (maximum of 5 characters)

- 1 In the »PROGRAM TABLE« menu, select the desired channel with »▼« or »▲«, »-« or »+«.
- 2 Highlight the channel with »□□« (yellow).
- 3 Select letters or numbers with »▼« or »▲«, move to the next position with »-« or »+«. and repeat.
- 4 Store the channel name with »□□« (yellow).

Note:

To enter additional channel names, repeat steps 1 to 4.

Skipping television channels

You can mark television channels which should be skipped during selection with »▼« or »▲«. A selection with the number keys is also possible.

- 1 In the »PROGRAM TABLE« menu, select the desired channel with »▼« or »▲«, »-« or »+«.
- 2 Highlight the channel with »👁« (red).
-The station is now displayed in red.
-You can deselect the selected channel by pressing the red button again.

Concluding the settings

- 1 Press »i« to finish the settings.

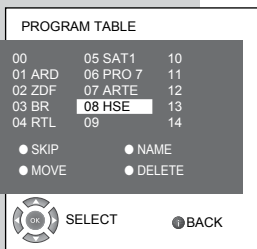
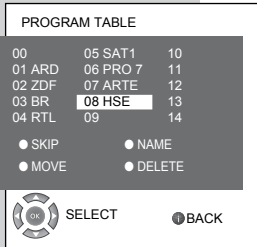

SETTINGS

Picture settings

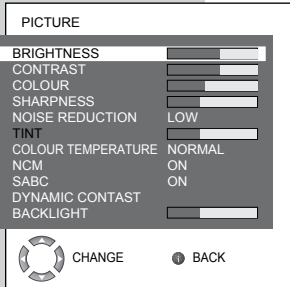

- 1 Press »i« to open the »MAIN MENU«.
- The »MAIN MENU« appears.
- 2 Select »PICTURE« with »▼« or »▲« and confirm with »●«.
- The »PICTURE« menu appears.

Brightness, contrast, colour and sharpness

- 1 Select »BRIGHTNESS«, »CONTRAST«, »COLOUR« or »SHARPNESS« with »▼« or »▲« and press »-« or »+« to change the setting.

Note:

The »BRIGHTNESS«, »CONTRAST«, »COLOUR« and »SHARPNESS« settings can only be adjusted if the »SABC« function is disabled.

Noise Reduction

You can improve the picture quality if the TV or video signal is poor.

- 1 Select »NOISE REDUCTION« with »▼« or »▲« and adjust the setting with »-« or »+«.

Tint

Compensates for colour discrepancies in NTSC programmes.

- 1 Select »TINT« with »▼« or »▲« and adjust the setting with »-« or »+«.

Colour temperature

You can change the colour from warm to cold hues.

- 1 Select »Colour temperature« with »▼« or »▲« and press »-« or »+« to adjust the setting.

NCM (Natural Colour Management)

Improves the colour saturation.

- 1 Select »NCM« with »▼« or »▲« and press »-« or »+« to select »On«.

SABC (Scene Adaptive Brightness Control)

Automatic brightness, contrast, colour and sharpness setting.

- 1 Select »SABC« with »▼« or »▲« and press »-« or »+« to select »On«.

SETTINGS

Dynamic Contrast

The background illumination is adjusted according to the picture content in order to optimise the contrast.

- 1 Select »Dynamic Contrast« with »▼« or »▲« and press »-« or »+« to select »On«.

Backlight

You can change the backlight of your LCD television.

- 1 Select »Backlight« with »▼« or »▲« and press »-« or »+« to adjust the setting.

Note:

The backlight can only be adjusted if the »DYNAMIC CONTRAST« function is not active.

Concluding the settings

- 1 Press »i« to finish the settings.

SETTINGS

Audio settings

- 1 Press **i** to open the »MAIN MENU«.
- The »MAIN MENU« appears.
- 2 Select »SOUND« with **▼** or **▲** and confirm with **●**.
- The »SOUND« menu appears.

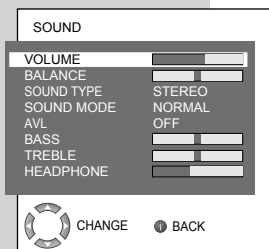

Volume, Bass, Treble and Balance

- 1 Select »VOLUME«, »BASS«, »TREBLE« or »BALANCE« with **▼** or **▲** and adjust the setting with **←** or **→**.

Stereo / two channel, mono

If the device receives two channel programmes, e.g. a film with the original sound on sound channel B (display: »DUAL II«) and the dubbed version on sound channel A (display: »DUAL I«), you can select the sound channel you desire.

If the device receives stereo or Nicam programmes, it switches automatically to stereo sound (display: »STEREO«).

You can switch the sound to »MONO« if the stereo reception quality is poor.

- 1 Select »SOUND TYPE« with **▼** or **▲** and adjust the setting with **←** or **→**.

Stereo width

Widens the audio output for stereo programmes and improves the sound with mono reception.

- 1 Select »SOUND MODE« with **▼** or **▲**.
- 2 Select the setting »Spatial« with **←** or **→**.

Automatic volume

The television channels broadcast at different volumes. The automatic volume limiting (AVL) function means the volume is kept the same when you switch between channels.

- 1 Select »AVL« with **▼** or **▲** and then select »On« with **←** or **→**.

Concluding the settings





- 1 Press **i** to finish the settings.

TELEVISION OPERATION







Basic functions





Switching on and off

- 1 Press »«, »1...0« or »« or »« to switch on the device from standby mode.
- 2 Press the »« button to switch the television to standby mode.

Selecting channels

- 1 Use »1...0« to select channels directly.
- 2 Press »« or »« to move up and down channels.
- 3 Open the channel list by pressing »«, select the station with »« or »« and press »« to confirm.
 - The display disappears automatically after a short while.

Selecting AV channels

- 1 Call up the »SOURCE« menu with »AV«.
- 2 Select the desired AV channel position with »« or »« and press »« to confirm.
- 3 Switch back to the television channel with »1...0«.

Adjusting the volume

- 1 Adjust the volume with »-« or »+«.

Muting

- 1 Use »« to switch the sound off (mute) and to switch it on again.

Displaying time

- 1 You can display the time by pressing the »« button.

Displaying information

- 1 Press »?« to display the information.
 - The display disappears automatically after a short while.

Picture settings

You can select different picture settings.

- 1 Select the desired picture setting from »USER«, »SOFT«, »NATURAL« or »RICH« with »«.
 - You can alter the »USER« picture setting, see the "Picture settings" chapter on page 13.

Audio settings

You can select different audio settings.

- 1 Select the desired sound setting from »USER«, »MUSIC«, »SPORTS«, »CINEMA« or »SPEECH« with »?«.
 - You can alter the »USER« sound settings, see the "Audio settings" chapter on page 15.

Zapping function

This function enables you to switch or zap between the two TV stations you last selected (select with »1...0« directly).

- 1 Press »1...0« to select the TV station.
- 2 Press »1...0« to switch to another TV station.
- 3 Press »Z« to switch between both TV stations.

TELEVISION OPERATION

Changing the picture format

The television automatically switches to the 16:9 format if this format is detected via the Euro-AV socket.

- 1 Select the picture format with »«. The selected picture format, for example »16:9«, appears on the screen.
 - You can choose between the following picture formats:

»AUTO« format

The picture format is automatically switched to »16:9« for 16:9 programmes.

For programmes in 4:3 format, the picture automatically fills the screen.

»16:9« and »14:9« formats

During programmes in 4:3 format, the picture is stretched horizontally if »16:9« or »14:9« is selected.

The picture geometry is stretched horizontally.

With actual 16:9 signal sources (from a set-top box on the Euro-AV socket) the picture fills the screen completely and with the correct geometry.

»4:3« format

The picture is shown in 4:3 format.

»LETTERBOX« format

The letterbox setting is especially suitable for programmes in 16:9 format.

The black borders which are usually at the top and bottom of the screen are eliminated, 4:3 pictures fill the screen.

The transmitted pictures are enlarged, but are slightly cropped at the top and bottom. The picture geometry remains unchanged.

»SUBTITLE« format

If you cannot read the subtitles which appear on the bottom of the screen, then select »SUBTITLE«.

»PANORAMA« format

During programmes in 4:3 format the picture is stretched horizontally if the »PANORAMA« function is selected. The picture geometry is stretched horizontally.

TELETEXT MODE

FLOF text and normal text mode

- 1 Press »**TXT**« to switch to teletext mode.
- 2 Use »**1...0**« to enter the page number directly or »**V**« and »**▲**« to switch up and down pages (to return to page 100, press »**i**«).

Note:

At the bottom of the screen, you will see an information line consisting of a red, green and, depending on the station, yellow and blue text field. Your remote control has buttons with the corresponding colours.

- 3 Press »**👁**« (red), »**🕒**« (green), »**🟡**« (yellow) or »**🟢**« (blue) to select a teletext page. This depends on the options in the information line.
- 4 Press »**TXT**« to switch off teletext mode.

Additional functions

Skipping the waiting time

While a page is being searched for, you can switch to the television channel.

- 1 Enter the teletext page number using »**1...0**« and then press »**P**«.
- As soon as the page is found, the page number is displayed.
- 2 Press »**P**« to switch to the teletext page.

Increasing character size

If you have difficulty reading the text on the screen, you can double the character size.

- 1 To enlarge the character size of a teletext page, press »**AV**« repeatedly.

Page stop

A multiple page may contain several sub-pages, which are automatically scrolled by the transmitting station.

- 1 Stop the sub-pages with »**PAT**«.
- 2 Press »**PAT**« to quit the function.



TELETEXT MODE

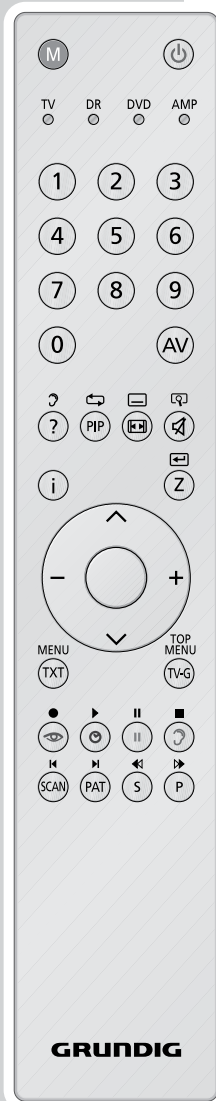

Calling up a sub-page directly

If the selected teletext page contains further pages, the number of the current sub-page as well as the total number of pages is displayed.

- 1 Call up the sub-pages with »S«.
- 2 Press »1...0« to enter the sub-menu.
- 3 Press »S« to quit the function.

Reveal answer

Certain teletext pages contain "hidden answers" or information which can be called up.

- 1 Display information with »?«.
- 2 Conceal information with »?«.

CONVENIENCE FUNCTIONS

Convenience functions with the »Features« menu

- 1 To open the »MAIN MENU« press »i«.
- 2 Select »FEATURES« with »V« or »^« and confirm with »●«.

Note:

Further operation is explained in the following sections.

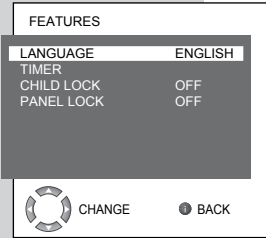

Changing the menu language

- 1 Select »LANGUAGE« with »V« or »^«
- 2 Select the language with »-« or »+«.
- 3 Press »i« to finish the setting.

Timers

A switch-on and switch-off time can be set in the »TIMER« menu. After this time has elapsed, the television switches to standby mode or switches on from standby mode. Enter the TV station in the channel number item and the television switches on to it.

- 1 Select »TIMER« with »V« or »^« and confirm with »●«.
- 2 Select »CLOCK«, »ON TIME«, »OFF TIME« or »PROGRAM NO« with »V« or »^«.
- 3 Enter the time, switch-on time, switch-off time or channel number with »1...0«.

Note:

You can delete the switch-on or switch-off time with »●«.

- 4 Press »i« to end the setting.

Keypad lock (parental control)

If the keypad lock is activated, the buttons on the television will be de-activated.

- 1 Select the »PANEL LOCK« with »V« or »^«.
- 2 Activate (ON) or deactivate (OFF) the keypad lock by pressing »-« or »+«.
- 3 Press »i« to end the setting.

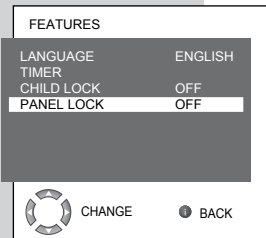
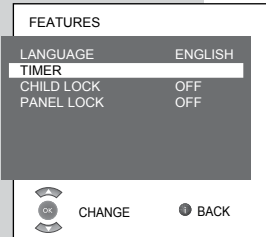

CONVENIENCE FUNCTIONS

Activating the parental lock

You can block programmes which are unsuitable for children.

- 1 Select the television channel with »**V**«, »**^**« or »**1...0**«.
- 2 To open the »MAIN MENU« press »**i**«.
- 3 Select »FEATURES« with »**V**« or »**^**« and confirm with »**●**«.
- 4 Select »CHILD LOCK« with »**V**« or »**^**«.
- 5 Activate the parental lock with »**-**« or »**+**« (On).
- 6 Press »**i**« to finish the setting.
- The selected channel position is now blocked.

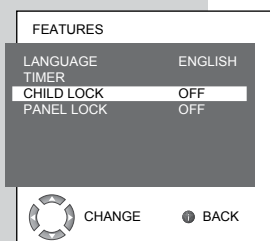

Deactivating the parental lock

- 1 Select the blocked television channel with »**1...0**«.
- 2 To open the »MAIN MENU« press »**i**«.
- 3 Select »FEATURES« with »**V**« or »**^**« and confirm with »**●**«.
- 4 Select »CHILD LOCK« with »**V**« or »**^**«.
- 5 Switch off the parental lock with »**-**« or »**+**« (Off).
- 6 Press »**i**« to finish the setting.

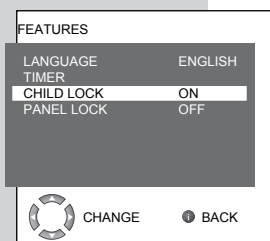

USING EXTERNAL DEVICES

DVD player, DVD recorder, video recorder or set-top box

Note:

Which television socket(s) you connect your external devices to depends on the sockets the external device is equipped with and the signals which are available.

Note that with many external devices the resolution of the video signal must be adapted to the input sockets on the television (check the external device's instruction manual). You can find out which values you need to set by referring to the guidelines in the section about connection options.

Note:

Do not connect any other equipment while the device is switched on. Switch off the other equipment as well before connecting it.

Only plug the device into the mains socket after you have connected the external devices.

High definition – HD ready

Your television can playback high-definition television signals (HDTV).

You can connect the input sources (HDTV set-top box or High Definition DVD player) to the »HDMI« socket (digital HDTV signal).

This ensures that you can view digital HDTV programmes, even if they are copy-protected (HDCP High Bandwidth Digital Content Protection).



Connecting a DVD player, DVD recorder, video recorder or set-top box

With a digital audio/video signal

Video signal: digital video; resolution: standard 576p; HDTV 720p, 1080i.

Audio signal: digital audio (stereo, multi-channel compression, uncompressed).

Channel position »HDMI 1«, »HDMI 2« or »HDMI 3«.

- 1 Connect the »HDMI1«, »HDMI2« or »HDMI3« socket on the television and the corresponding HDMI socket on the external device using a standard HDMI cable (digital video and audio signal).

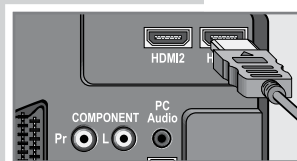

USING EXTERNAL DEVICES

With an analogue video signal (progressive)

Video signal: YUV; resolution: standard 576p; HDTV 720p, 1080i.

Audio signal: stereo, analogue.

Channel position »YPbPr«.

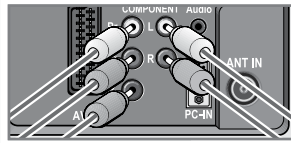

1 Connect the »**COMPONENT INPUT Y Pb Pr**« sockets on the television and the corresponding sockets on the external device using cinch cables (video signal).

2 Connect the »**COMPONENT INPUT AUDIO IN L R**« sockets on the television to the corresponding sockets on the external device using cinch cables (audio signal).

Using the Euro/AV socket

Video signal: FBAS/RGB.

Audio signal: stereo, analogue.

Channel position »SCART«.

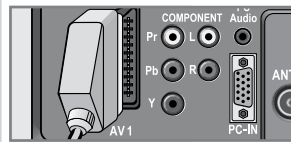
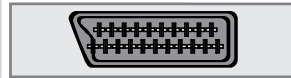

1 Connect the »**AV1**« socket on the television and the corresponding socket on the external device using a EURO-AV cable (video and audio signal).

With S-Video signal

Video signal: Y/C.

Audio signal: stereo, analogue.

Channel position »S-Video«.

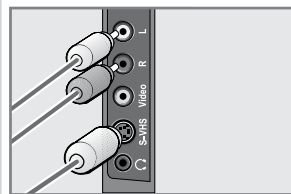

1 Connect the »**S-VHS**« socket on the television and the corresponding socket on the external device using an S-Video cable (video signal).

2 Connect the »**L R**« sockets on the television to the corresponding sockets on the external device using cinch cables (audio signal).

USING EXTERNAL DEVICES

With an analog TV signal

Video signal: FBAS.

Audio signal: stereo, analogue.

Channel position »AV«.

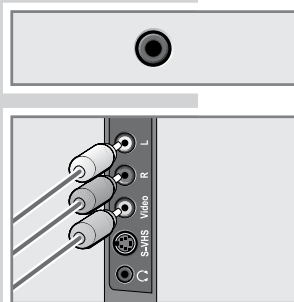

- 1 Connect the »Video« cinch socket on the television and the corresponding socket on the external device using cinch cables (video signal).
- 2 Connect the »L R« sockets on the television to the corresponding sockets on the external device using cinch cables (audio signal).

Using a video recorder, DVD player or set-top box

1 Switch on the video recorder, DVD player or set-top box and select the function you wish to use.

2 Press »AV«, select the input signal channel with »V« or »^« (»SCART«, »AV«, »S-Video«, »HDMI 1«, »HDMI 2«, »HDMI 3« or »YPbPr«) and press »●« to confirm.

Headphones

Connecting headphones

1 Plug the headphone jack (3.5 mm jack plug) into the headphone socket.

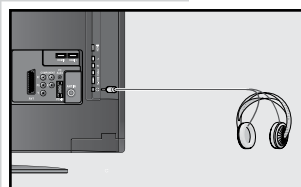

Selecting the sound settings for the headphones

- 1 Press »i« to open the »MAIN MENU«.
- 2 Select »SOUND« with »V« or »^« and confirm with »●«.
- 3 Select »Headphone« with »V« or »^«.
- 4 Press »-« or »+« to adjust the headphone volume.
- 5 Press »i« to finish the setting.

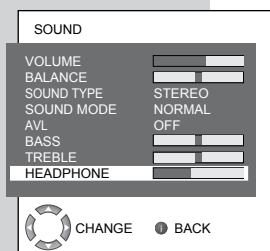

USING EXTERNAL DEVICES

Decoder or satellite receiver

In order for the television to receive encoded programs from a privately operated station, a decoder is needed.

Connecting a decoder or satellite receiver

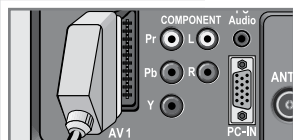
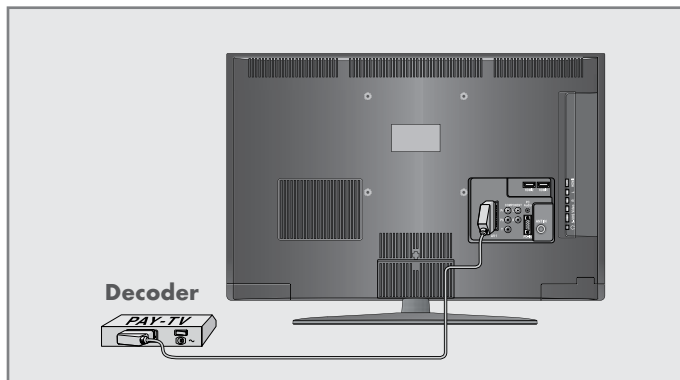

- 1 Connect the »SCART« socket on the television set and the appropriate socket on the decoder using a EURO-AV cable.

Using a decoder or satellite receiver

- 1 Switch on the television and the decoder or the satellite receiver.
- 2 Press »AV«, select the channel »SCART« with »V« or »^« and press »●« to confirm.

USING EXTERNAL DEVICES _____

Camcorder

Connecting the camcorder

- 1 Connect the yellow socket »**Video**« on the television and the corresponding socket on the camcorder (VHS, Video 8) with a cinch cable (picture signal);

or

connect the »**S-VHS**« socket (picture signal) on the television and the corresponding socket on the camcorder (S-VHS, Hi 8) with a S-Video cable.

- 2 Connect the white and red sockets »**L R**« on the television and the corresponding sockets on the camcorder with a cinch cable (audio signal).

Note:

There must not be video signals at »**Video**« and »**S-VHS**« sockets at the same time. This could lead to picture disturbances.

Operating with a camcorder

- 1 Switch on the camcorder, insert a cassette and start playback.
- 2 Press »**AV**«, select the »**AV**« or »**S-VIDEO**« channel with »**▼**« or »**▲**« and press »**●**« to confirm.

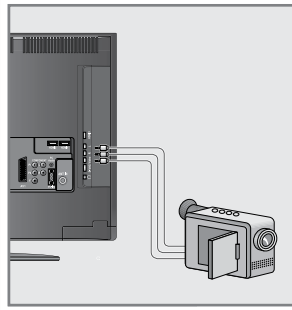

PC MONITOR MODE

Connecting a PC

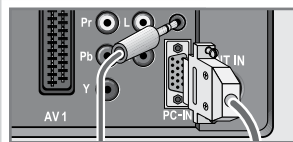
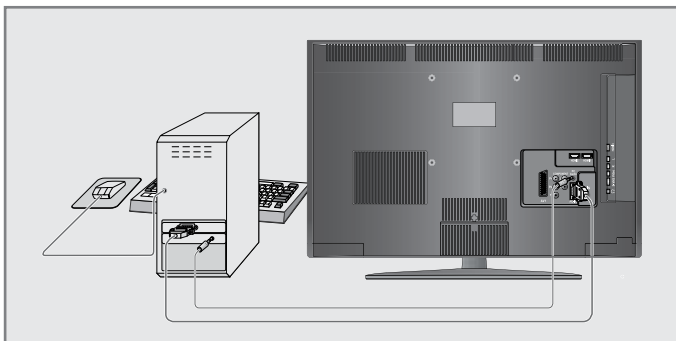

- 1 Connect the socket »**PC-IN VGA**« on the television to the corresponding socket on the PC using a VGA cable.
- 2 Connect the socket »**PC AUDIO IN**« on the television to the corresponding socket on the PC using a cinch cable (audio signal).

Note:

Adjust your PC to the monitor (for example, picture resolution 1280 x 768, picture frequency 60 Hz).

Selecting the channel position for the PC

- 1 Press »**AV**«, select the »**PC**« channel with »**V**« or »**A**« and press »**●**« to confirm.

Settings for the PC

- 1 Press »**i**« to open the »**MAIN MENU**« menu.
– The »**MAIN MENU**« menu appears.
- 2 Select »**SETUP**« with »**V**« or »**A**« and press »**●**« to confirm.
- 3 Select the function or setting you want with »**V**« or »**A**« and press »**-**« or »**+**« to execute it.
– Options:
»**AUTOCONFIGURATION**« For automatic PC configuration;
»**HORIZONTAL POS.**« Adjust the picture position horizontally;
»**VERTICAL POS.**« Adjust the picture position vertically;
»**CLOCK**« Set the cycle frequency;
»**PHASE**« Remove horizontal flicker, blurring and horizontal lines.
- 4 Press »**i**« to exit the »**SETUP**« menu.

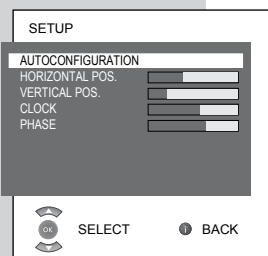

SPECIAL SETTINGS

Setting television channels

This setting is only necessary if a new channel comes on air and you do not want to change the order of your channels. The television channel can be set directly or using the search.

Setting channels using the search

- 1 Press »i« to open the »MAIN MENU«.
- The »MAIN MENU« appears.
- 2 Select »SETUP« with »▼« or »▲« and confirm with »●«.
- The »SETUP« menu appears.
- 3 Select »PROGRAM NO« with »▼« or »▲« and set the preset channel with »-« or »+«.
- 4 Select »Search« with »▼« or »▲« and start the search with »-« or »+«.
- If a strong station signal is received, the search is interrupted and the picture appears. Repeat the search until the channel you want appears on the screen.

Note:

The current system is automatically displayed in the »SYSTEM« line. Select »SYSTEM« with »▼« or »▲« if the colour or sound are incorrect. Select the setting required with »-« or »+«.

- 5 Select »Store« with »▼« or »▲« and confirm with »-« or »+«.
- The »STORED« message appears.

Note:

To set other television stations, repeat steps 3 to 5.

- 6 Press »i« to finish the setting.

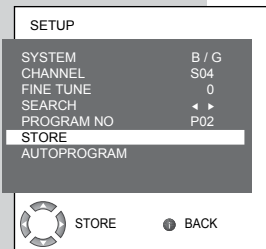
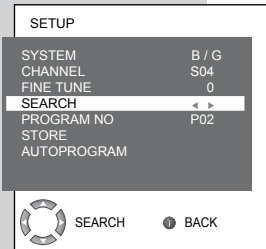
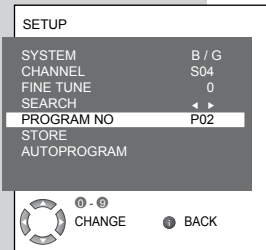

SPECIAL SETTINGS

Fine tuning television channels

The television automatically tunes itself to the best possible reception. You may need to carry out manual fine tuning in areas where there is poor reception.

- 1 Press »i« to open the »MAIN MENU«.
- The »MAIN MENU« appears.
- 2 Select »SETUP« with »▼« or »▲« and confirm with »●«.
- The »SETUP« menu appears.
- 3 Select »FINE TUNE« with »▼« or »▲« and set it with »-« or »+«.
- 4 Select »Store« with »▼« or »▲« and confirm with »-« or »+«.
- The »STORED« message appears.
- 5 Press »i« to finish the setting.

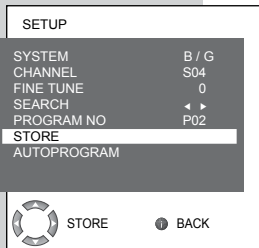
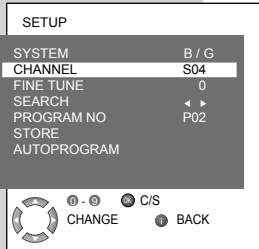
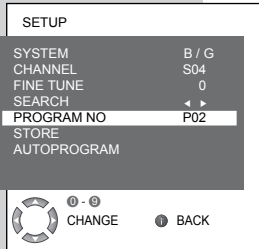
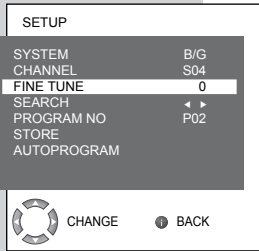

Setting the television channels by entering the channel numbers

- 1 Press »i« to open the »MAIN MENU«.
- The »MAIN MENU« appears.
- 2 Select »SETUP« with »▼« or »▲« and confirm with »●«.
- The »SETUP« menu appears.
- 3 Select »PROGRAM NO« with »▼« or »▲« and set the preset channel with »-« or »+«.
- 4 Select »CHANNEL« with »▼« or »▲«.
- 5 Press »●« to choose between »S« (special channel) and »C« (channel).
- 6 Press »-« or »+« to switch up and down channels or use »1...0« to enter the channel number directly.

Note:

The current system is automatically displayed in the »SYSTEM« line. Select »SYSTEM« with »▼« or »▲« if the colour or sound are incorrect. Select the setting required with »-« or »+«.

- 7 Select »Store« with »▼« or »▲« and confirm with »-« or »+«.
- The »STORED« message appears.

Note:

To set the other television stations, repeat steps 3 to 7.

- 8 Press »i« to finish the setting.

SPECIAL SETTINGS

Re-tuning all television channels

You can re-tune all the television stations, for example if you move to another town.

- 1 Select the channel with »V«, »^« or »1...0«, to select the preset number from which the new television channels will be added to the channel list, e.g. 1.
- 2 Press »i« to open the »MAIN MENU«.
- 3 Select »SETUP« with »V« or »^« and confirm with »●«.
- The »SETUP« menu appears.
- 4 Select »AUTOPROGRAM« with »V« or »^« and confirm with »●«.
- The »COUNTRY SELECTION« menu appears.
- 5 Press »V« or »^«, »-« or »+« to select the country.
- 6 Press »●« to start the search.
- The search begins. It may last a few minutes, depending on the number of television stations found.
- The automatic search may last a few minutes, depending on the number of television channels received.

Note:

You can interrupt the search by pressing »i«.

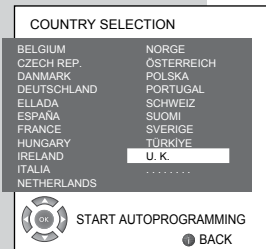
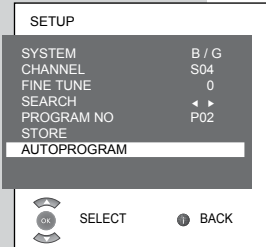

INFORMATION

Technical data

Operating voltage:	220-240V ~, 50-60 Hz
Power consumption:	in operation 140 W in standby approx <1 W
Sound output:	2 x 20 watts music (2 x 10 sine wave)
Reception range:	C01 ... C80, special channels S01 ... S41
Preset channels:	100 and 8 AV
Screen size:	81 cm/32"
Max. resolution:	WXGA 1366 x 768
Weight:	approx 11 kg

Service information for dealers

The television set may only be operated with the mains adapter supplied.

The product complies with the following EU directives: 2006/95/EG directive for electrical equipment to be used within defined voltage ranges. 2004/108/EG directive on electromagnetic compatibility.

The device complies with the following standards: EN 60065, EN 55013, EN 55020, EN 55022, EN 55024.

Environmental note

This product has been made from high-quality parts and materials which can be re-used and recycled.

Therefore, do not throw the product away with normal household waste at the end of its life. Take it to a collection point for recycling electrical and electronic devices. This is indicated by this symbol on the product, in the operating manual and on the packaging.

Please find out about collection points operated by your local authority.

Help protect the environment by recycling used products.

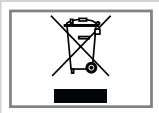

INFORMATION

Troubleshooting

If the remedies given below do not work, please consult an authorised GRUNDIG dealer. Please bear in mind that malfunctions can also be caused by external devices such as video recorders or satellite receivers.

Problem	Possible cause	Remedy
Screen lit (snow), but no station	Antenna cable	Is the antenna cable connected?
	No TV station programmed	Start a station search
Poor picture contrast	Picture settings incorrectly set	Adjust the brightness, contrast or colour setting
	Problem at station	Test with a different station
Interference to picture and/or sound	Interference from other devices	Change the position of the device
Ghosting, reflection	Channel setting	Automatic or manual channel setting/fine tuning
	Antenna	Have antenna cable or system checked
No colour	Colour intensity at maximum	Turn up the colour
	TV standard setting (if setting option is available)	Select the correct colour standard
	Problem at station	Test with a another channel
Picture but no sound	Volume set to minimum	Turn up or switch on the volume
Teletext missing or faulty	Problem at station	Test with a another channel
	Television station (has no teletext) or antenna system	Test another channel for fine tuning and ghosts
	Station signal too weak	Check the antenna system
Remote control does not work	No optical connection	Point the remote control at the television set
	Remote control batteries	Check the batteries, change if necessary
	Operating condition undefined	Switch off the television with the main power button for approximately 2 minutes
Picture is dark in PC mode	Incorrect setting for picture resolution and picture frequency on the PC	Change the setting on the PC (for example, picture resolution 1280 x 768, picture frequency 60Hz)

NOTE:

This is a Class A product. During operation the device can cause radio interference. In this case the user may have to remedy this. Please contact your specialist dealer.