



**Table top cooker
STO 811 - STO 811 E**

Please read this manual first.

Dear Customer,

We would like you to obtain best performance with your product that has been manufactured in modern facilities and passed through strict quality control procedures.

Therefore, we advise you to read through this User Manual carefully before using your product and keep it for future reference. If you hand over the product to someone else, deliver the User Manual as well.

The User Manual will help you use the product in a fast and safe way.

- Read the User Manual before installing and operating the product.
- You must strictly observe the safety instructions.
- Keep this User Manual within easy reach for future reference.
- Also read other documents supplied with the product.
Remember that this User Manual may also be applicable for several other models.
Differences between models are explicitly identified in the manual.

Explanation of symbols

Throughout this User Manual the following symbols are used:

 Important information or useful hints about usage.

 Warning for hazardous situations with regard to life and property.

 Warning for electric shock.

 Warning for risk of fire.

 Warning for hot surfaces.

Table of Contents

1 General information..... 4

Overview 4

Technical specifications 5

Accessories supplied with the unit 5

2 Safety instructions..... 6

Explanation of safety instructions 6

General safety 6

Safety for children 7

Safety when working with gas 7

Intended use 8

Disposal 8

Disposing of packaging material 8

Disposing of the old product 8

Future Transportation 9

3 Installation..... 10

Before installation 10

Installation and connection 10

4 Preparation..... 13

Tips for saving energy 13

Initial operation 13

First cleaning of the appliance 13

5 How to use the hob..... 14

General information about cooking 14

Using the hobs 14

6 Maintenance and care 16

General information 16

Cleaning the hob 16

7 Troubleshooting 17

1 General information

Overview

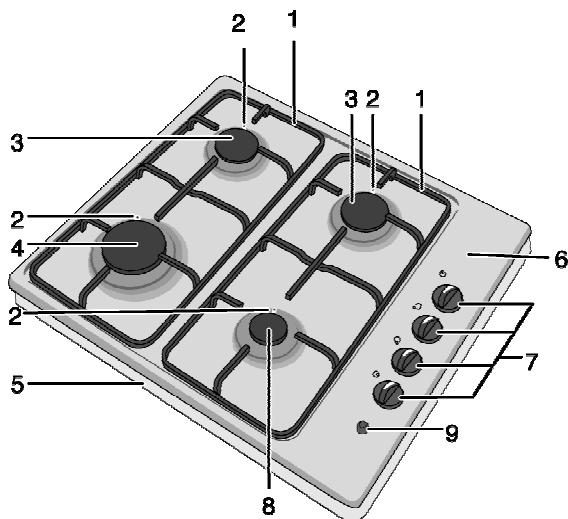

- | | | | |
|---|---------------|---|-------------------|
| 1 | Pan support | 5 | Frame |
| 2 | Spark plug | 6 | Burners' plate |
| 3 | Normal burner | 7 | Gas burner's knob |
| 4 | Rapid burner | 8 | Auxiliary burner |

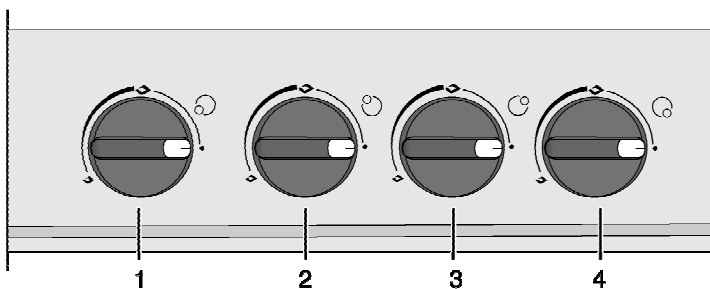

- | | | | |
|---|------------------------------|---|--------------------------|
| 1 | Auxiliary burner Front right | 3 | Normal burner Rear left |
| 2 | Rapid burner Front left | 4 | Normal burner Rear right |

Technical specifications

External dimensions (height / width / depth)	100 mm/580 mm/510 mm
Voltage / frequency	220-240 V ~ 50 Hz
Cable type / section	H05RR-FG 3 x 0,75 mm ²
Cable length	max. 2 m
Category of gas product	II 2H 3B/P
Gas type / pressure	LPG G 30/30 mbar
Total gas consumption	7.9 kW
Converting the gas type / pressure ^s – optional	NG G 20/20 mbar

Burners

Front right	Auxiliary burner
Power	1000 W
Front left	Rapid burner
Power	2900 W
Rear left	Normal burner
Power	2000 W
Rear right	Normal burner
Power	2000 W

i Technical specifications may be changed without prior notice to improve the quality of the product.

i Figures in this manual are schematic and may not exactly match your product.

i Values stated on the product labels or in the documentation accompanying it are obtained in laboratory conditions in accordance with relevant standards. Depending on operational and environmental conditions of the product, these values may vary.

Accessories supplied with the unit

i Accessories supplied can vary depending on the product model. All the accessories described in the user manual may not exist on your product.

Coffee pot adaptor







Can be used for a coffee pot.

2 Safety instructions

Explanation of safety instructions

The following types of safety instructions and information are used in this manual. They can be distinguished by the symbol and the initial signal word.

-  **High risk of personal injury.**
Non-observance may or will cause serious injuries or death.
-  **Risk of personal injury.**
Non-observance may or will cause minor or medium injuries.
-  **Risk of material damage.**
Non-observance may or will cause damage on the appliance or other objects.
-  **Tip for the user.**
Useful information on how to use the appliance. No injury risk information.

General safety

- This product is not intended to be used by persons with physical, sensory or mental disorders or unlearned or inexperienced people (including children) unless they are attended by a person who will be responsible for their safety or who will instruct them accordingly for use of the product.
Children must be supervised to prevent them from tampering with the product.
- Connect the product to a grounded outlet/line protected by

a fuse of suitable capacity as stated in the "Technical specifications" table. Have the grounding installation made by a qualified electrician while using the product with or without a transformer. Our company shall not be liable for any damages that will arise due to using the product without a grounding installation in accordance with the local regulations.

- Do not operate the product if the power cable or plug is damaged. Call Authorized Service Agent.
- Do not operate the product if it is defective or has any visible damage.
- Do not carry out any repairs or modifications on the product. However, you may remedy some troubles that do not require any repairs or modifications. See *Troubleshooting, page 17*.
- Never wash down the product with water! There is the risk of electric shock!
- Never use the product when your judgment or coordination is impaired by the use of alcohol and/or drugs.
- Product must be disconnected from the mains during installation, maintenance, cleaning and repair procedures.
- Installation and repair procedures must always be performed by Authorized Service Agents. Manufacturer shall not be held responsible for damages arising

from procedures carried out by unauthorized persons and may void the warranty.

- Be careful when using alcoholic drinks in your dishes. Alcohol evaporates at high temperatures and may cause fire since it can ignite when it comes into contact with hot surfaces.
- Do not heat closed tins and glass jars in the oven. The pressure that would build-up in the jar may cause it to burst out.
- Do not place any flammable materials close to the product as the sides become hot during use.
- Keep all ventilation slots clear of obstructions.
- Make sure that the product is switched off after every use.
- Do not close the top cover before the hotplates or burners cool down. Wipe the top cover dry before opening it in order to avoid water leakage to the rear and inner sections of the oven.

 Call Authorized Service Agent for the installation of the product. Warranty period will start after this procedure.

Safety for children

- Accessible parts of the appliance will become hot whilst the appliance is in use and until the appliance has cooled, children should be kept away.
- Do not store any items above the appliance that children may reach.
- The packaging materials will be dangerous for children. Keep the packaging materials away from children. Please dispose of all

parts of the packaging according to environmental standards.

Safety when working with gas

- Any works on gas equipment and systems may only be carried out by authorised qualified persons who are Gas Safe registered.
- "Prior to the installation, ensure that the local distribution conditions (nature of the gas and gas pressure) and the adjustment of the appliance are compatible."
- "This appliance is not connected to a combustion products evacuation device. It shall be installed and connected in accordance with current installation regulations. Particular attention shall be given to the relevant requirements regarding ventilation;" See *Before installation, page 10*
- "**CAUTION:**"The use of a gas cooking appliance results in the production of !heat, moisture and products of combustion" in the room in which it is installed. Ensure that the kitchen !is well ventilated especially when the appliance is in use": keep natural ventilation holes open or install a mechanical ventilation device (mechanical extractor hood). Prolonged intensive use of the appliance may call for additional ventilation, for example increasing the level of the mechanical ventilation where present."
- Gas appliances and systems must be regularly checked for proper functioning. Please arrange for annual maintenance.

- Clean the gas burners regularly. The flames should be blue and burn evenly.
- Good combustion is required in gas appliances. In case of incomplete combustion, carbon monoxide (CO) might develop. Carbon monoxide is a colourless, odourless and very toxic gas, which has a lethal effect even in very small doses.
- Request information about gas emergency telephone numbers and safety measures in case of gas smell from you local gas provider.

What to do when you smell gas

⚠ Risk of explosion and poisoning! Put out all naked flames and do not smoke, strike matches or do anything that could cause ignition. Do not operate any electric switches (e.g. light switch, TV, computer, cooker or door bell). Do not use a telephone or mobile phone.

1. Turn off all valves on gas appliances and gas meter at the main control valve, unless it's in a confined space or cellar.
2. Open doors and windows.
3. Check all tubes and connections for tightness. If you still smell gas leave the property.
4. Warn the neighbours.
5. Call the fire-brigade. Use a telephone outside the house.
 - 5.1 If you have door or gates that are secured by an electric lock,

or entry phone, please open these manually.

6. Do not re-enter the property until you are told it is safe to do so.

Intended use

This product is designed for domestic use. Commercial use is not admissible. "CAUTION: This appliance is for cooking purposes only. It must not be used for other purposes, for example room heating."

The manufacturer shall not be liable for any damage caused by improper use or handling errors.

Service life of your product is 10 years. Manufacturer shall provide the required spare parts for the product to perform as defined during this period.

Disposal

Disposing of packaging material

Packaging materials are dangerous to children. Keep packaging materials in a safe place out of reach of children. Packaging materials of the product are manufactured from recyclable materials. Dispose of them properly and sort in accordance with recycled waste instructions. Do not dispose of them with normal domestic waste.

Disposing of the old product



Dispose of the old product in an environmentally friendly manner. This equipment bears the selective sorting symbol for waste electrical and electronic equipment (WEEE). This means that this equipment must be



handled pursuant to European Directive 2002/96/EC in order to be recycled or dismantled to minimize its impact on the environment. For further information, please contact local or regional authorities.

Electronic equipments not included in the selective sorting process are potentially dangerous for the environment and human health due to the presence of hazardous substances. Refer to your local dealer or solid waste collection centre in your area to learn how to dispose of your product. Before disposing of the product, cut off the power cable plug and make the door lock (if any) unusable to avoid dangerous conditions to children.

Future Transportation

- Keep the product's original carton and transport the product in it.

Follow the instructions on the carton. If you do not have the original carton, pack the product in bubble wrap or thick cardboard and tape it securely.

- Secure the caps and pan supports with adhesive tape.
- Do not use the door or handle to lift or move the product.
-  Do not place other items on the top of the appliance. The appliance must be transported upright.
-  Check the general appearance of your product for any damages that might have occurred during transportation.

3 Installation

Before installation

- The appliance corresponds to device class 1, i.e. it may be placed with the rear and **one** side to kitchen walls, kitchen furniture or equipment of any size. The kitchen furniture or equipment on the **other** side may only be of the same size or smaller.
- Any kitchen furniture next to the appliance must be heat-resistant (100 °C min.).

Room ventilation

The air for combustion is taken from the room air and the exhaust gases are emitted directly into the room.

Good room ventilation is essential for safe operation of your appliance. If there is no window or door available for room ventilation, an extra ventilation must be installed.

Do not install this appliance in a room below ground level unless it is open to ground level on at least one side.

Failure to install correctly is dangerous and could result in prosecution.

Prolonged intensive use of the appliance may call for additional ventilation, for example the opening of a window, or the use of permanent fixed mechanical ventilation system, for example, an extractor fan or cooker hood that ventilates to the outside.

Room size	Ventilation opening
In the cellar or basement	min. 65 cm ²

Installation and connection

i Do not install the appliance next to refrigerators or freezers. The heat emitted by the appliance will lead to an increased energy consumption of cooling appliances.

- Appliance to be installed in accordance with the local authority requirements for gas, electricity and any other authority having jurisdiction.

Connection to the gas supply

⚠ Risk of explosion or poisoning by unprofessional installation. The appliance may be connected to the gas distribution system only by an authorized qualified person who is Gas Safe registered.

⚠ Risk of explosion! Before starting any work on the gas installation, please shut off the gas supply.

- "The adjustment conditions for this appliance are stated on the label (or data plate)."

i Your appliance is adjusted for LP gas.

Connecting the gas hose

- Have your appliance connected in a way that it will be close to the

Room size	Ventilation opening
smaller than 5 m ³	min. 100 cm ²
5 m ³ to 10 m ³	min. 50 cm ²
greater than 10 m ³	not required

gas connection and avoid gas leakage.

- Plastic hose to be used must not be longer than 125 cm.
- Install the clamp to the hose. Soak one end of the hose (15 mm inner diameter) into boiling water for one minute to soften it.
- Then, slip the softened end of the hose completely onto the sharp hose end of your appliance. Finally, tighten the clamp completely by a screwdriver.
- Repeat the same procedure for the other end of the hose and complete the gas bottle connection.
- Never forget to make the gas leakage control.

⚠ Risk of explosion and suffocation!
LPG bottles must not be stored in the house.

- If you need to use your appliance later with a different type of gas, you must consult the authorized service for the related conversion procedure.

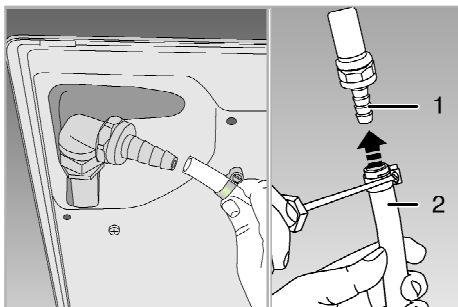

- 1 Hose nozzle for LPG
- 2 Safety tube

Leakage control at the connection part

- Make sure that all knobs on the appliance are turned off. Make sure that the gas supply is open. Prepare soapy foam and apply it onto the connection edge of the hose for gas leakage control.
- Soapy part will froth if there is a gas leakage. In this case, inspect the gas connection once again.

i Never use a match or lighter to make the gas leakage control.

⚠ Risk of explosion by damage of the safety tube!
The safety tube must not be clamped, bent or trapped or come into contact with hot parts of the appliance.

Connection to the mains supply

i This appliance must be earthed!

Our company shall not be held responsible for any damage caused by using the appliance without earthed socket.

⚠ Risk of electric shock, short circuit or fire by unprofessional installation!
The appliance may be connected to the mains supply only by an authorized qualified person and the appliance is only guaranteed after correct installation.

-  Risk of electric shock, short circuit or fire by damage of the mains lead!
The mains lead must not be clamped, bent or trapped or come into contact with hot parts of the appliance.
If the mains lead is damaged, it must be replaced by a qualified electrician.

The mains supply data must correspond to the data specified on the rating plate of the appliance. The rating plate is located at the rear housing of the appliance.

The supply cable of the appliance must correspond to the specifications; see technical data table *Technical specifications*, page 5.

-  The plug should be easily accessible after installation (but not above the hob).

Plug the mains lead into the socket.

Final check

1. Turn on gas supply.
 2. Check gas installations for secure fitting and tightness.
 3. Ignite burners and check appearance of the flame.
-  The flames should be blue and burn smoothly. If the flames appear yellowish, check secure position of the burner cap or clean the burner. Switch off gas and let burner cool before touching it.

4 Preparation

Tips for saving energy

The following information will help you to use your appliance in an ecological way, and to save energy:

- Defrost frozen dishes before cooking them.
- Use pots/pans with cover for cooking. If there is no cover, energy consumption may increase 4 times.
- Select the burner which is suitable for the bottom size of the pot to be used. Always select the correct pot size for your dishes. Larger pots require more energy.

Initial operation

First cleaning of the appliance

i The surface may get damaged by some detergents or cleaning materials.

Do not use aggressive detergents, cleaning powder/cream or any sharp objects.

1. Remove all packaging materials.
2. Wipe the surfaces of the appliance with a damp cloth or sponge and dry with a cloth.

5 How to use the hob

General information about cooking

⚠ Risk of fire by overheated oil!
When you heat oil, do not leave it unattended.

Never try to extinguish the fire with water! When oil has caught fire, immediately cover the pot or pan with a lid. Switch off the hob if safe to do so and phone the fire service.

- Before frying foods, always dry them well and gently place into the hot oil. Ensure complete thawing of frozen foods before frying.
- Do not cover the vessel you use when heating oil.
- Place the pans and saucepans in a manner so that their handles are not over the hob to prevent heating of the handles. Do not place unbalanced and easily tilting vessels on the hob.
- Do not place empty vessels and saucepans on cooking zones that are switched on. They might get damaged.
- Operating a cooking zone without a vessel or saucepan on it will cause damage to the product. Turn off the cooking zones after the cooking is complete.
- As the surface of the product can be hot, do not put plastic and aluminum vessels on it. Such vessels should not be used to keep foods either.
- Use flat bottomed saucepans or vessels only.

- Put appropriate amount of food in saucepans and pans. Thus, you will not have to make any unnecessary cleaning by preventing the dishes from overflowing.
Do not put covers of saucepans or pans on cooking zones.
Place the saucepans in a manner so that they are centered on the cooking zone. When you want to move the saucepan onto another cooking zone, lift and place it onto the cooking zone you want instead of sliding it.

Gas cooking

- Size of the vessel and the flame must match each other. Adjust the gas flames so that they will not extend the bottom of the vessel and center the vessel on saucepan carrier.

Using the hobs

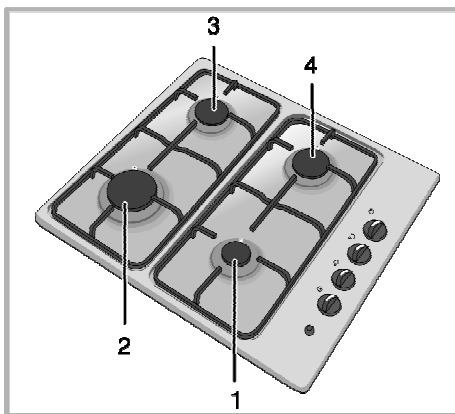

- 1 Auxiliary burner 12-18 cm
- 2 Rapid burner 22-24 cm

- 3 Normal burner 18-20 cm
- 4 Normal burner 18-20 cm is list of advised diameter of pots to be used on related burners.

Large flame symbol indicates the highest cooking power and small flame symbol indicates the lowest cooking power. In turned off position (top), gas is not supplied to the burners.

Igniting the gas burners

1. Keep burner knob pressed.
2. Turn it counter clockwise to large flame symbol.
 - » Gas is ignited with the spark created.
3. Adjust it to the desired cooking power.

Turning off the gas burners

Turn the keep warm zone knob to off (upper) position.

Gas shut off safety system (in models with thermic component)

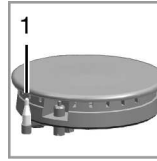

As a counter measure against blow out due to fluid overflows at burners, safety mechanism trips and shuts off the gas.

1. Gas shut off safety

- Push the knob inwards and turn it counter clockwise to ignite.
- After the gas ignites, keep the knob pressed for 3-5 seconds more to engage the safety system.
- If the gas does not ignite after you press and release the knob, repeat the same procedure by keeping the knob pressed for 15 seconds.



Risk of deflagration incase of unburned gas!



Do not press the knob for longer than 15 seconds if there was no ignition.

Wait for one minute and then repeat the ignition process.

6 Maintenance and care



General information

Service life of the product will extend and frequent problems will decrease if the product is cleaned at regular intervals.

-  Risk of electric shock!
Switch off the electricity before cleaning appliance to avoid an electric shock.
-  Hot surfaces may cause burns!
Allow the appliance to cool down before you clean it.
- Clean the product thoroughly after each use. In this way it will be possible to remove cooking residues more easily, thus avoiding these from burning the next time the appliance is used.
- No special cleaning agents are required for cleaning the product. Use warm water with washing liquid, a soft cloth or sponge to clean the product and wipe it with a dry cloth.
- Always ensure any excess liquid is thoroughly wiped off after cleaning and any spillage is immediately wiped dry.
- Do not use cleaning agents that contain acid or chloride to clean the stainless or inox surfaces and

the handle. Use a soft cloth with a liquid detergent (not abrasive) to wipe those parts clean, paying attention to sweep in one direction.

(optional) - Do not use solid metal scrapers or abrasive cleaning materials to clean the glass cover. Glass surface can get damaged.

-  The surface may get damaged by some detergents or cleaning materials.
Do not use aggressive detergents, cleaning powder/cream or any sharp objects.
-  Do not use steam cleaners for cleaning.

Cleaning the hob

Gas hobs

1. Remove and clean the saucepan carriers and burner caps.
2. Clean the hob.
3. Install the burner caps and make sure that they are seated correctly.
4. When installing the upper grills, pay attention to place the saucepan carriers so that the burners are centered.

7 Troubleshooting

- ⚠** Risk of explosion or poisoning by unprofessional repair.
Repairs on the appliance must be carried out by an approved service centre.

Normal operating conditions

- Smoke and smell may emit for a couple of hours during the first operation.
- When the metal parts are heated, they may expand and cause noise.

Before you call the service, please check the following points.

Gas

Malfunction/problem	Possible cause	Advice/remedy
No ignition spark is produced.	No electric supply to the appliance.	Check fuses in the fuse box.
No gas is emitted.	Main gas tap is closed.	Open gas tap.
	Safety tube is bent.	Install safety tube without bends.
Burners do not burn smoothly or not at all.	Burners are dirty.	Clean burner parts.
	Burners are not dry.	Dry burner parts.
	Burner cap is not securely positioned.	Position burner correctly.
	Gas tap is closed.	Open gas tap.
	Gas container is empty (in case of LPG connection).	Replace gas container.

If the problem has not been solved:

1. Separate unit from the mains supply (deactivate or unscrew fuse).
2. Call the after-sales service of your store reseller.

i Do not attempt to repair the appliance yourself. There are no customer service items inside the appliance.