

CLOCK RADIO

SC 990



FOR A GOOD REASON

GRUNDIG

| | |
|-------------------|------------------|
| DEUTSCH | 03 - 18 |
| ENGLISH | 19 - 34 |
| FRANÇAIS | 35 - 50 |
| ITALIANO | 51 - 66 |
| PORTUGUÊS | 67 - 82 |
| ESPAÑOL | 83 - 98 |
| NEDERLANDS | 99 - 114 |
| POLSKI | 115 - 130 |
| DANSK | 131 - 146 |
| SVENSKA | 147 - 162 |
| SUOMI | 163 - 178 |
| TÜRKÇE | 179 - 197 |

Packing contents

SC 990

Remote control

1 battery (Lithium CR2032)

Mains adapter 5.9 V, 1500 mA

Operating manual

Special features

The device receives FM radio stations.

The MP3 music data format can be played back via the USB input using a MP3 Player, a USB memory stick or a card reader.

Use the Aux input to connect any other audio sources.

SET-UP AND SAFETY

Please note the following instructions when setting up the system:

- The device is designed for the playback of audio signals. Any other use is expressly prohibited.
- If you want to set up the device on wall shelves or in cupboards, please ensure that it is adequately ventilated. There must be at least 10 cm of space at the side, above and behind the device.
- Do not cover the device with newspapers, table cloths, curtains, etc.
- When setting up the device, remember that furniture is often coated with various types of varnish and plastic, which often contain chemical additives. These additives may cause corrosion to the feet of the unit. This may leave stains on the surface of the furniture which can be difficult or impossible to remove.
- If the device is exposed to sudden changes in temperature, for example when taken from the cold into a warm room, wait at least two hours before using it.
- The device is designed for use in dry rooms. If you use it outdoors, make sure it is protected from moisture such as dripping or splashing water.
- Only use the device in a moderate climate.
- Do not place the device close to heating units or under direct sunlight, as this will impair cooling.

- Do not place any vessels containing liquids, such as vases, on the device.
- Do not place any objects such as burning candles on the device.
- Thunderstorms are a danger to all electrical devices. Even if the device is switched off, it can be damaged by a lightning strike to the mains cable. Always disconnect the mains cable during a storm.
- Continuous use at high volume level can cause damage to the user's hearing. 
- If malfunctions occur due to static electricity charges or brief mains voltage surges, reset the device. To do this, pull out the mains adapter and connect it again after a few seconds.
- Do not open the device casing under any circumstances. Warranty claims are excluded for damage resulting from improper handling.
- Do not connect any other equipment while the device is switched on.
- Switch off the other devices as well before connecting them.
- Only plug the device into the mains socket after you have connected the external devices.
- Make sure the power plug is freely accessible.

OVERVIEW

The device controls

The front, the right and the left side of the device

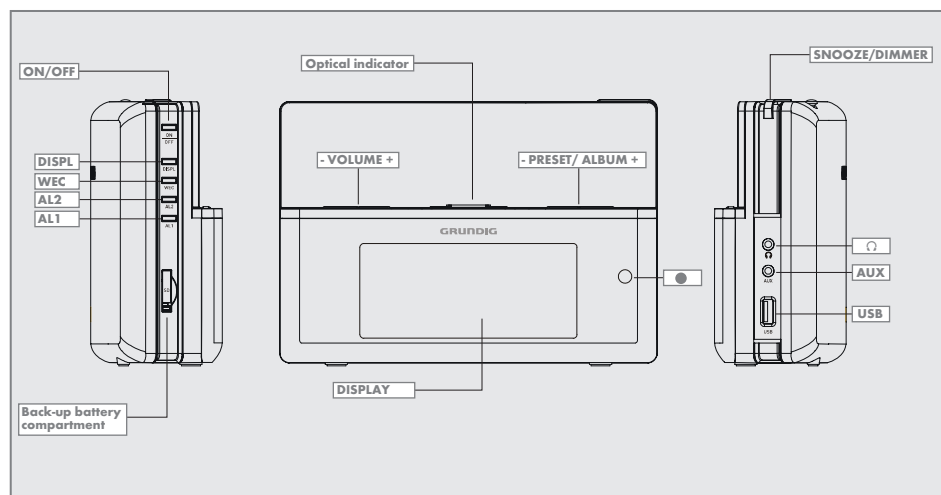

ON/OFF Switches the device to and from stand-by mode.

DISPL Displays information about the FM radio stations as well as when using a USB device.

WEC Deactivates and activates the alarm function for the weekend.

AL1 AL2 Press and hold down to start setting the alarm times.
Press to activate and deactivate the alarm times.

- VOLUME + Adjusts the volume.

Back-up battery compartment For inserting the back-up battery.

Optical indicator Lights up, if the Alarm timer switched on the device.

■ Display of the device; for more details, please see "The display" section.

- PRESET/ ALBUM + In FM mode: Selects the presets.
In USB mode: Selects the file folders.

● Infrared sensor for remote control signals.

SNOOZE/ DIMMER Interrupts the alarm function.
Adjusts the brightness of the display to one of three levels (high, medium, low).

🎧 Headphone socket for connecting a stereo headphone set with a jack plug (ø 3.5 mm). This automatically switches off the loudspeakers.

AUX Audio signal input for connecting an external device.

USB USB port type A. For connecting MP3 player, a USB memory stick or a card reader.

OVERVIEW

The top and the back of the device

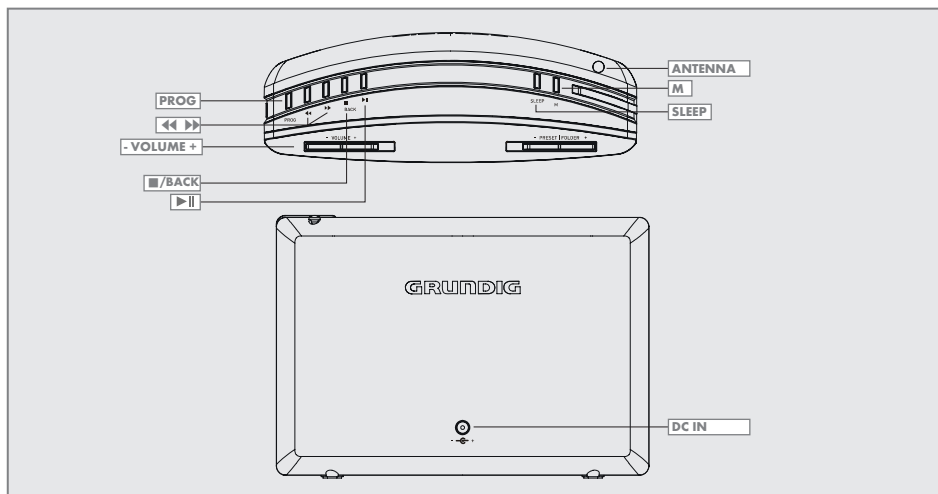

PROG

In FM radio mode: Press for activating the memory function and confirming the selected station.
In stand by mode: Press and hold down to start setting the time and date.



In FM radio mode: Press to start the station search. It stops when a station is found.

In USB mode: Briefly press to search backwards or forwards for files or tracks. Press and hold to search backwards and forwards for a certain passage of a track.

■/BACK

Interrupts the playback (in USB mode).



Starts and pauses playback (in USB mode).

M

Selects the different audio sources for USB, FM and AUX modes.

SLEEP

Activates the setting for the sleep timer.

ANTENNA

Antenna for FM reception.

DC IN

For connecting the power supply unit (5,9 V = 1500 mA).

Note:

- The only way to fully disconnect the device from the mains is to pull out the plug.

OVERVIEW

The remote control



- ⏻** Switches the device to stand-by mode and from stand-by mode to the last input source selected.
- M** Selects the audio sources for USB, FM and AUX In modes.
- 1-9, +10** Number buttons, selects presets for FM stations (in FM radio mode).
- S** Adjusts the brightness of the display to one of three levels.
- 🔊** Switches the loudspeaker of the device to mute and back on again.
- DISPL** Displays information on the FM radio stations as well as when using the USB.
- PROG** In FM radio mode: Press for activating the memory function and confirming the selected station.
In stand by mode: Press and hold down to start setting the time and date.
- BACK** No function.
- ∨ / ∧** In FM radio mode: Select presets.
In USB mode: Select folders.
- OK** No function.
- +** Sets the volume.
- ▶||** Starts and pauses playback (in USB mode).
- / ∞** Interrupts the playback (in USB mode).
In FM radio mode: Press to switch between stereo and mono.
- ◀◀ ▶▶** In FM radio mode: Press to start the station search. It stops when a station is found.
In USB mode: Briefly press to skip backwards or forwards for files or tracks. Press and hold to search backwards and forwards for a certain passage of a track.
- ↶ WEC** In USB mode: Repeats all files.
In timer mode: Deactivates and activates the alarm for the weekend.
- AL1 AL2** Press and hold down to start setting the alarm times.
Press to activate and deactivate the alarm times.
- SLEEP** Sets and deactivates the sleep timer.

OVERVIEW

The display

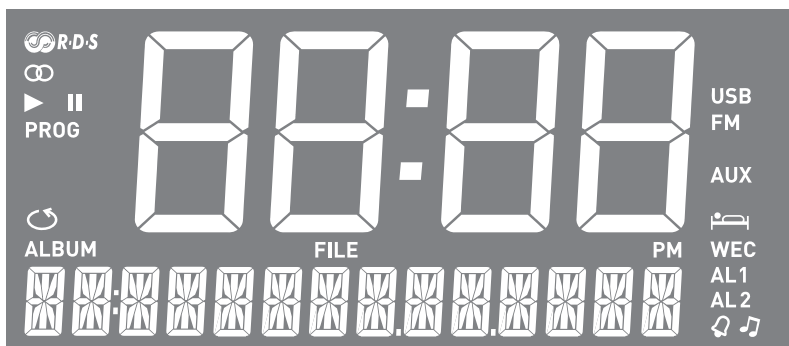

87.165 MHz

In stand-by: Displays the current time and date.

Displays the volume setting.
In FM radio mode: Displays the frequency, the station name or the station type, RDS information if provided and the preset for a saved radio station.

In USB mode: Displays information in the file.

In AUX mode: Displays current time and date.

The device is receiving a RDS station.

A stereo station is being received.

Playback.



Pauses playback.

PROG

The programmed presets.



The current album is repeated (flashing).

The current file is repeated.

USB

The selected source.

FM AUX



The sleep timer is active.

WEC

The alarm timer for the week-end is deactivated.

AL1 AL2

The alarm timer is active.



The switch on timer for the buzzer is active.



The switch on timer for FM/USB is active.

CONNECTION AND PREPARATION

Connecting external devices

Note:

- Switch the device off before you connect external devices.

- 1 Use a standard audio cable to connect the audio output of the external device to the socket »AUX« on the right of the device.

Connecting an MP3 player, a USB memory stick or a card reader

The device supports most MP3 Players, USB memory sticks or card readers.

Note:

- The device must be switched off while the USB connection is being made. If it is not switched off, data could be lost.

- 1 Connect the USB interface of the MP3 player or the card readers to the »USB« socket on the device (on the right) using a standard USB cable;
or
insert the USB plug of the USB memory stick in the »USB« socket on the device (on the right).

Notes:

- To remove the MP3 player, the USB memory stick or the card readers, switch off the device and pull out the data medium.
- The USB socket on the device does not support a connection for a USB extension cable and is not designed for directly connecting to a computer.

Connecting the headphones

- 1 Insert the headphone plug (ø 3.5 mm) into the »« socket on the right side of the device.
 - The loudspeaker of the device is switched off.

Note:

- Excessive sound pressure from the earphones or headphones can cause hearing loss.

Connecting to the mains supply

Notes:

- Check that the mains voltage on the type plate (on the back of the power adapter) corresponds to your local mains supply. If this is not the case, contact your specialist dealer.
 - Before connecting the power adapter plug to the wall socket, ensure that all other connections have been made.
- 1 Insert the plug of the supplied power adapter cable into the »DC IN« socket on the back of the device.
 - 2 Plug the power adapter into the wall socket.

Caution:

- The device is connected to the mains with the power adapter. Pull out the power adapter plug if you want to completely disconnect the device from the mains.
- Make sure that the power adapter plug is easily accessible during operation and not hindered by other objects.

CONNECTION AND PREPARATION

Installing battery in the remote control

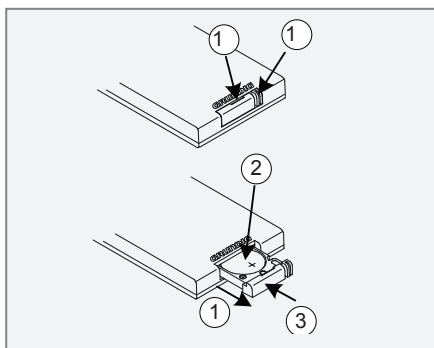

- 1 Open the battery compartment by pushing the small latch to the left and at the same time sliding the battery tray out.
- 2 Insert one CR2032 battery into the battery tray with the correct polarity as shown on the battery tray.
- 3 Slide the battery tray into the battery compartment until it clicks into its place.

Installing back-up battery in the device

During mains operation, the back-up battery ensures that the stored settings are not lost in the case of a power failure or when the device is briefly disconnected from the mains.

- 1 Open the back-up battery compartment on the left side of the device by pushing the small latch upwards and at the same time sliding the battery tray out.
- 2 Insert one CR2032 battery into the battery tray with the correct polarity as shown on the battery tray.
- 3 Slide the battery tray into the battery compartment until it clicks into its place.

Notes:

- Do not expose the batteries to extreme heat, caused for example by direct sunlight, heaters or fire.
- Remove the batteries when they are flat or when you know that the device will not be used for a long period of time.

Environmental note:

- Batteries, including those which do not contain heavy metal, should not be disposed of with household waste. Always dispose of used batteries in accordance with local environmental regulations.

Initial setup

When the device is connected to the mains for the first time, »0:00« starts flashing and »WELCOME TO ...« appears on the display.

Searching for and saving FM stations

You can fill 20 presets with the FM radio stations of your choice. If you assign the presets again, the previously saved stations will be overwritten.

1 Switch on the device from stand-by mode by pressing »« on the remote control or »ON/OFF« on the device.

2 Press »M« repeatedly until »FM« appears on the display.

3 To tune stations automatically:

Press and hold »« or »«.

When you release the button, the automatic search stops at the next station.

- If RDS information is transmitted by the broadcaster, then the device shows the station name.



To tune stations manually

Move the frequency forward in brief steps by repeatedly pressing »« or »«.

- The frequency goes up or down in 50 kHz steps.

4 Press »PROG«.

- An available preset number flashes on the display.

5 To select a preset number, press »- PRESET/ALBUM +« on the device or »« or »« on the remote control within 5 seconds.

6 To store the selected channel press »PROG« within 5 seconds.

- Display: The stored station with the preset number is shown.



7 To search and store more stations, repeat steps 3 to 6 as many times as necessary.



Setting the time and date

1 Switch off the device by pressing »« on the remote control or »ON/OFF« on the device.

2 Press and hold down »PROG«.
- Display: »12 H« or »24 H« flashes.



3 Press »« or »« to chose 12 H or 24 H mode and press »PROG« to confirm.
- Display: The hour flashes.



4 Press »« or »« briefly to set the hours step by step or hold down to run through the hours continuously and press »PROG« to confirm.
- Display: The minutes flash.



5 Press »« or »« briefly to set the minutes step by step or hold down to run through the minutes continuously and press »PROG« to confirm.
- Display: The year flashes.

Note:

■ When the minute displays changes from »59« to »00«, this does not affect the hour display.

6 Press »« or »« briefly to set the year step by step or hold down to run through the years continuously and press »PROG« to confirm.
- Display: The month flashes.

7 Press »« or »« briefly to set the month step by step or hold down to run through the months continuously and press »PROG« to confirm.
- Display: The day flashes.

8 Press »« or »« briefly to set the day step by step or hold down to run through the days continuously and press »PROG« to confirm.
- Display: The current time and date.

SETTINGS

Adjusting the display brightness

1 Press repeatedly »**SNOOZE/DIMMER**« on the device or »**S**« on the remote control to change the brightness of the display in three levels (high, medium, low).

Notes:

- Minimum power consumption in stand-by mode is only achieved if the backlight in the display is switched to minimum.
- Your device is equipped with a sensor which measures the brightness of the environment and adjust the brightness of the display.

GENERAL FUNCTIONS

Switching on and off

1 Switch on the device from stand-by mode by pressing »**⏻**« on the remote control or »**ON/OFF**« on the device.

- Display: The system switches to the last source selected.

2 Switch the device to stand-by mode by pressing »**⏻**« on the remote control or »**ON/OFF**« on the device.

- Display: The current time and date.

Note:

- The only way to disconnect the device from the mains supply is to pull out the plug from the wall socket.

Selecting the input source

1 Press »**M**« repeatedly to select »**USB**«, »**FM**« or »**AUX**« on the display.

Adjusting the volume

1 Adjust the volume by pressing »**-**« or »**+**« on the remote control;

or

»**- VOLUME +**« on the device.

Muting

You can switch the device speaker to and from mute mode using this function.











1 Activate mute with »**🔇**« on the remote control.

- Display: »**MUTE ON**«.

2 Deactivate mute with »**🔇**« on the remote control.

- Display: »**MUTE OFF**«.



Playing the contents of an USB data medium

- 1 Switch off the device from stand-by mode by pressing »« on the remote control or »**ON/OFF**« on the device.
- 2 Connect the USB interface of the MP3 player or the card reader to the »**USB**« socket on the device (on the right side), using a standard USB cable;
or
insert the USB plug of the USB memory stick in the »**USB**« socket (on the right side) on the device.
- 3 Switch on the device from stand-by mode by pressing »« on the remote control or »**ON/OFF**« on the device.
- 4 Press »**M**« repeatedly until »**USB**« appears on the display.
- Display: »**READ**« and then the content of the USB (Album and Files).
- 5 Select the album by pressing »- **PRESET/ALBUM** +« on the device or »« or »« on the remote control.
- 6 Select the file or track by pressing »« or »«.
- 7 Press »« to start playback.
- Display: Playback starts, file information appears on the display.
- 8 Press »/BACK« on the device or »/»« on the remote control to stop playback.

Resume function

When the USB operation is resumed after switching the device off and then on, or if the program source has been changed, playback continues from the start of the last selected title.



This function is not possible if another MP3 player or USB memory stick is connected.

To initialise the new medium and to play the first title press »/BACK« twice on the device or »/»« on the remote control.





Displaying information

- 1 During playback, press »**DISPL**« on the remote control.
- Display: The album and file numbers, the ID3 Tag, the title, the artist, the album is shown.

Pausing and continue playback





- 1 Press »« during playback to pause.
- Display: »**||**«.
- 2 Continue playback by pressing »«.

Repeating the current track





- 1 During playback, press »« or »«.
- Display: The current album and file numbers appear, the track is played again from the start.

Selecting another file or track









During playback

- 1 During playback, press »« or »« repeatedly until the desired track or file is reached.
- Playback of the selected file or track starts automatically.







In stop mode

- 1 In stop mode, press »« or »« until the desired track or file is reached.
- 2 Start playback of the file or track by pressing »«.







Searching for a passage within a file or track

- 1 During playback, press and hold »« or »«.
- 2 Release »« or »« when the passage has been found.
- Playback continues.

Repeating Album

- 1 During playback press »/WEC« once on the remote control.
 - Display: »  « flashes.
 - The current album is played back repeatedly.
- 2 To quit this function, press repeatedly »/WEC« on the remote control until the symbol disappears.
 - Display: »  « disappears.

Repeat file (one)

- 1 During playback press »/WEC« twice on the remote control.
 - Display: »  «.
 - The current file or track are played back repeatedly.
- 2 To quit this function, press repeatedly »/WEC« on the remote control until the symbol disappears.
 - Display: »  « disappears.

Notes:

- The USB socket on the device does not support a connection for a USB extension cable and is not designed for direct connection to a computer.
- The USB socket of this device is a standard socket. Due to rapid advances in technology and new manufacturers appearing every day, the compatibility of USB memory sticks can only be partially guaranteed.
- If USB operation is impaired or is not possible, this does not indicate a device malfunction.
- Bi-directional data transfer as defined for ITE devices in EN 55022/EN 555024 is not possible.
- USB transfer itself is not in an operating mode. It is only an additional function.
- Never remove USB data medium during operation. This could damage the USB data medium and the device. Any such damage will invalidate your warranty.

FM MODE

Selecting the tuner input source

1 Press **»M«** repeatedly on the remote control or on the device until **»FM«** appears on the display.

Selecting stations – from presets

1 In the **»FM«** mode, press **»1«** to **»+10«** on the remote control to select the presets from 1 to 20 or press **»- PRESET/ALBUM +«** on the device repeatedly until the required preset is found.

- The frequency of the station and the preset number appear on the display and the station is played then.

Note:

- To select presets from 10 to 20, press +10 and then the number button corresponding to the ones' place. For example to select 18, press **»+10«** and **»8«** consecutively.

Setting stereo or mono reception (only in FM radio mode)

1 Press **»■/○«** on the remote control to switch between stereo and mono modes.

Displaying RDS station information

If the device is receiving a RDS station, the station name and **»R.D.S.«** appear on the display (if no information is available, the reception frequency appears on the display).

Station and track information appear as ticker text (radio text). If radio text is not available, other information can be displayed as an alternative.

1 To display information on the current RDS station, press **»DISPL«** repeatedly.

- The following information appear:

The current programme type (PTY), e.g. **»POP MUSIC«, »NO PS«, »NO TEXT«, »NO TYPE«** appears if no information is available.

Note:

- The information is displayed continuously until **»DISPL«** is pressed again.

AUX MODE

Listening to an external source

You can listen to the audio signal from the external device connected through your device speaker.

1 Use a standard audio cable (not supplied) to connect **»AUX«** on the right side of the device to an AUDIO OUT socket on the external equipment.

2 Switch on the device from stand-by mode by pressing **»⏻«** on the remote control or **»ON/OFF«** on the device.

3 Press **»M«** repeatedly until **»AUX«** appears on the display.

4 Start playback on the external device.

TIMER MODE

Your device has 2 timer modes:

- The alarm timer, which switches the device on at the set time and wakes you with the input source you selected.
- The sleep timer, which switches the device off at a preset time.

Alarm timer

Setting the alarm time

1 Press and hold down »AL1«.

- Display: The last alarm time set and »ON TIME« »AL1« and the hour flash alternately.

2 Press »◀◀« or »▶▶« briefly to set the hours step by step or hold down to run through the hours continuously.

Press »AL1« to confirm.

3 Press »◀◀« or »▶▶« briefly to set the minutes step by step or hold down to run through the minutes continuously.

Press »AL1« to confirm.

- Display: The alarm on time is set and »OFF TIME« appears on display.

4 Press »◀◀« or »▶▶« briefly to set the hours step by step or hold down to run through the hours continuously.

Press »AL1« to confirm.

5 Press »◀◀« or »▶▶« briefly to set the minutes step by step or hold down to run through the minutes continuously.

Press »AL1« to confirm.

- Display: The alarm off time is set and »SOURCE« appears on display.

6 Press »◀◀« or »▶▶« briefly to set the source step by step or hold down to run through »RADIO«, »BUZZ« and »USB« continuously.

Press »AL1« to confirm.

- Display: The alarm source is set and »VOLUME« appears on display.

7 Press »◀◀« or »▶▶« briefly to set the volume step by step or hold down to run through »10-31« and »FM« continuously.

Press »AL1« to confirm.

- Display: The alarm is set and »AL1« appears on the display.

Notes:

- To set the second alarm time (»AL2«) repeat steps 1 to 7.
- If no button is pressed for 10 seconds while setting, the system will quit the process automatically, and you have to start again.

Interrupting the alarm timer

1 While the alarm is sounding, press »SNOOZE/DIMMER«.

Viewing the alarm time

1 Press »AL1« or »AL2«.

Note:

- If no other button is pressed, the device switches back automatically to the current time after 10 seconds.

Cancelling the alarm for the day

1 While the alarm is sounding, press »ON/OFF« on the device or »⏻« on the remote control.

- The alarm signal stops, the alarm remains at the set time for the next day.

Deactivating and activating alarm in stand-by

1 To deactivate the alarm, press »AL1« or »AL2« once.

- Display: »AL1« or »AL2« disappears. The set alarm time is stored.

2 To activate the alarm, press »AL1« or »AL2« again.

- Display: »AL1« or »AL2« appears.



TIMER MODE

Deactivating and activating the alarm for the weekend

- 1 In stand-by, press »WEC« on the remote control or on the device.
 - Display: »WEC«. The alarm function is deactivated for the weekend.
- 2 To activate the alarm, press »WEC« again.
 - Display: »WEC« disappears. The alarm function is activated for the weekend.

Sleep timer

Setting the sleep timer

- 1 Switch on the device by pressing »« on the remote control or »ON/OFF« on the device and select the preferred sound source.
- 2 Press »SLEEP«.
- 3 To set the switch-off time from »90«, »75«, »60«, »45«, »30«, »15«, »OFF« press »SLEEP« repeatedly.
 - Display: »« and the switch-off time appears.
 - After the selected time has elapsed the device switches off, »« disappears.

Cancelling the sleep timer

- 1 To switch off the sleep timer before the set switch-off time, refer to previous section and select »OFF« at step 3;
or
switch the device to stand-by mode by pressing »« on the remote control or »ON/OFF« on the device.

Cleaning the device

Pull out the power cord from the wall socket. Clean the device by using a soft cloth slightly moistened with a mild detergent solution. Do not use a solution containing alcohol, spirits, ammonia or abrasives.

Environmental note



This product has been manufactured with high quality parts and materials which can be reused and are suitable for recycling.

Therefore, do not dispose the product with normal domestic waste at the end of its service life. Take it to a collection point for the recycling of electrical and electronic equipment. This is indicated by this symbol on the product, in the operating manual and on the packaging.

Please consult your local authorities to learn the nearest collection point.

Help protect the environment by recycling used products.

Technical data



This device is noise-suppressed according to the applicable EU directives.

This product fulfils the European directives 2004/108/EC, 2006/95/EC and 2009/125/EC.

The type plate is located on the bottom of the device.

System

Operating voltage: 100 - 240 V~ , 50/60 Hz
with adapter

Output: 5.9 V \equiv 1500 mA $\text{--}\oplus$

Adapter model no: OH-1015A0591500U-VDE

Max. power
consumption: 9 W

Receiver unit

Reception range FM: 87.5 ...108.0 MHz

File format

MP3

USB

USB 2.0 compatible FAT 32

Dimensions and weight

Dimensions: W x H x D
200 x 140 x 70 mm

Weight: 0.77 kg

Technical and design modifications reserved.

Troubleshooting

Not every kind of sound interference is caused by a defect in your device. Cables that have accidentally been disconnected and flat batteries for the remote control will impair functioning. If the following measures do not resolve the problem satisfactorily, please visit www.grundig.com, product range:audio, internet radios or contact your specialist dealer.

General Faults

| Problem | Possible cause/remedy |
|---|---|
| No sound. | The volume setting is too low – increase the volume. The headphones are plugged in – disconnect the headphones. Power cable is not properly connected – connect the power cable properly. Mute is activated – deactivate mute. |
| The device does not react when the buttons are pressed. | Static electrical discharge – switch off the device, disconnect the power cable and plug it in again after a few seconds. |
| The remote control does not work. | The battery is flat – replace the battery. The remote control is out of range of the device. |
| Poor radio reception. | Weak antenna signal, check antenna. Interference from electrical devices such as televisions, video recorders, computers, neon lamps, thermostats or motors. Keep the device away from such equipment. |

AUS GUTEM GRUND

GRUNDIG

www.grundig.com

72011 411 5400 12/09