



*3420 FD*

*automatic  
washing  
machine*

***OPERATING  
INSTRUCTIONS***



**This product  
has been manufactured at  
environmental friendly modern  
facilities.**

Dear Customer,

We wish that this product, manufactured at modern facilities with total quality notions, will deliver you the best performance. In order to guarantee this, please read this instruction manual thoroughly and keep it for your future reference.



## CONTENTS

- Part 1:  
Technical features.
- Part 2:  
Steps before operating Fullautomatic  
Washing Machine and safety precautions.
- Part 3:  
Preparation
- Part 4:  
Program selection and washing operations.
- Part 5:  
Care and Maintenance.
- Part 6:  
Determining location and installation
- Part 7:  
Helpful tips on stain removal
- Part 8:  
Before calling service.

# Part 1: | Technical features

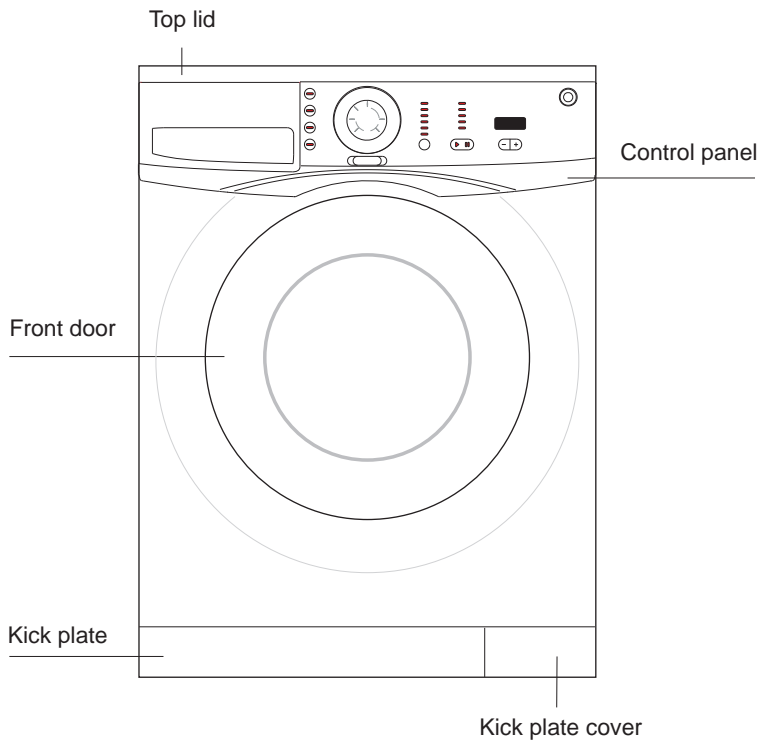

Capacity (dry fabric)	3.5
Height	85
Width	60
Depth	35
Net weight	57
Power requirement	220/50
Nominal current	10
Power	1700
Washing speed	52
Spin speed	1000



The appearance and specifications are subject to change without notice to raise the unit quality.

The graphics shown in the manual are schematic and it is possible that they not conform with your washing machine.

## Part 2: | Steps before operating Fullautomatic Washing Machine and safety precautions.

The current requirement in order for safe operation of this machine is 16 Amperes. You will need to have a certified electrician to connect a 16 Amp fuse, if there is not enough current load.

Your washing machine is set to 230 Volts.

Do not forget to check the grounding in all cases of use with or without the transformer. Our company will not be responsible for any damages caused by operations without grounding.

In order to bring the machine to ready before use, please call your service technician or a certified plumber.

The performance of the washing machine depends on the effectiveness of the cleaning agent. Stains can be permanent if low quality detergents are used. Please take necessary effort to clean the stained clothes as described in following pages before washing them in the machine.

Your washing machine is designed only for domestic use.

If the power cord or the plug is damaged, please call a certified technician.

Always use new "water inlet hose" received within your machine.

Please perform the first wash with detergent, at COTTON 90 program and without placing your laundry inside the washing machine. This will ensure that the drum is free from any left over dirt from production .



Due to the quality control processes during production, there may be some water left over in your machine. This does not cause any damage to your product.

● **Attention!** Before any operation of the machine check the following.

- Did you close the front door?
- Is the tap open?
- Is water drain hose placed properly?
- Is power connected?

### ● **Sorting laundry**

Sort the laundry according to the following groups and wash them separately:

- white and resistant colored fabrics,
- colored fabrics,
- delicate fabrics (silk, rayon etc.),
- wool.

Be sure to empty pockets and remove any belts, buttons, pins, etc. from the clothing. You can place little clothing materials (baby socks, etc) inside of pillow cases to avoid them slip into the pump and filter. For stained fabrics, refer to the “Practical information” section of the operating manual.

### ● **To open the front door**

press the “door open button. For your safety, front door can be opened only when the machine is off.

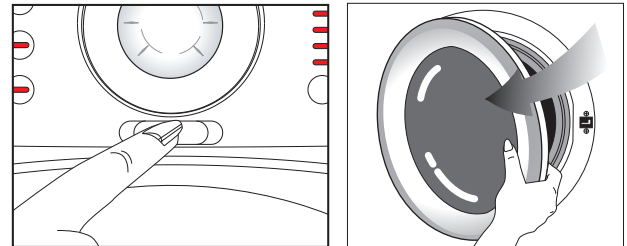

### ● **Loading the machine**

Place the fabrics uniformly inside the machine. Hand knits should be placed inside out in the machine. Make sure that there is no clothing at the side of the door. Close the door by pushing lightly. If the door does not close completely, the machine could not be started-a safety measure. Front door is locked until the end of the washing program and it will not be opened about 2 minutes following the end of the program.

## Detergent and softener selection

Choose the appropriate detergent specifically used at the full automatic washing machines. Suggested amount is given on the detergent cover.

Do not attempt to use detergents and bleaching elements that contain chlor and sulphur. The amount of the detergent depends on the dirt level of fabric, the amount of fabric and the softness of the water.

## Detergent Dispenser

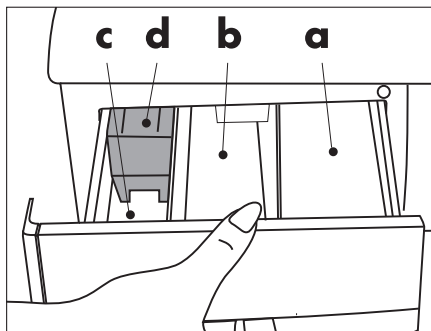

- a. Compartment I. detergent compartment for prewash cycle.
- b. Compartment II. detergent compartment for wash cycle.
- c. "☼" Compartment for fabric conditioner.
- d. Siphon.



**WARNING!**  
When the CURTAIN program is selected Pre-wash function is automatically set. Pre-wash can be operated even without detergent.



**Attention!** Fill the softener according to the supplier recommendation (app. <100 ml). Do not exceed the "MAX level" marked on the detergent dispenser.

# Control Panel

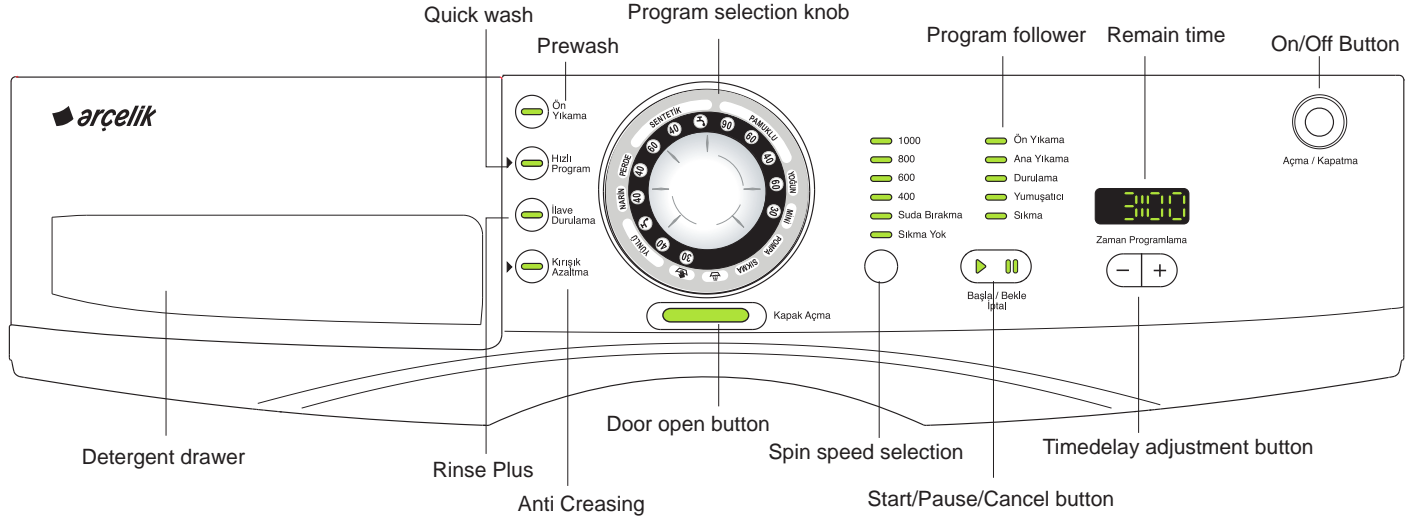

## Functions

### Quick wash

Shortens washing time for lightly soiled fabrics. This function can be used for cotton and synthetic programs for temperatures below 60° C.

### Rinse plus

By using this function your machine will add another rinse process to the three rinse processes that it has already done. This additional rinse will reduce any affects on sensitive skin by washing leftover detergent.

### Anti Creasing

To avoid wrinkling of your clothes, select this function. When Anti-Creasing is chosen please load less cloth, this way a special washing and spinning profile will reduce the wrinkles and your clothes will be easy to iron.

-  1000
-  800
-  600
-  400
-  Suda Birakma
-  Sıkma Yok

### Spin Speed Selection

Using this button, you can select final spin speed upto 1000 rpm. If you do not want to apply spinning to your clothes, select “ Sıkma Yok ” option.

### Rinse Hold

If you desire to leave your synthetic and wool fabrics in the machine after the wash program you may select the Rinse hold option to prevent them getting wrinkled. If you want to cancel the “Rinse Hold” function, you have to press on “Start/Pause/Cancel” button first, select the desired spin speed and then repress on the “Start/Pause/Cancel” button.



## Part 4: Program Selection and Washing Machine Operation

Insert the plug. Press the On/Off button and then the Door Open button. Open the door. Place your laundry into the machine according to the recommended load capacity and close the front door.

Select the proper program according to the dirt strength and the thermostat value by means of Program Selection Table given on the following pages.

Turn the program selection knob and set the desired program. Select the spin speed according to the desired program. Select desired auxiliary functions.

Then, fill the fabric softener and the detergent into the related compartments, and close the detergent dispenser box. Push the Start/Cancel/Pause button to operate your machine. In the mean time the Start/Cancel/Pause led  will be on. You can follow the washing steps by means of the program follower.

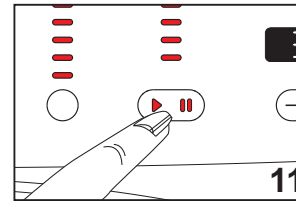
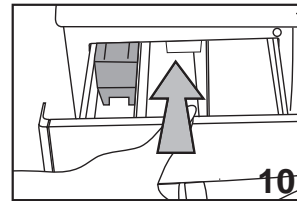
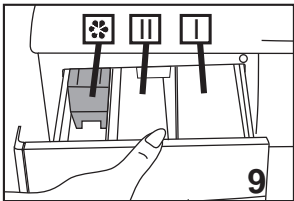
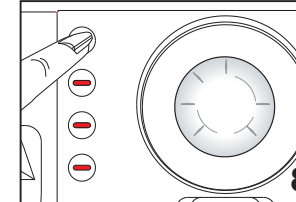
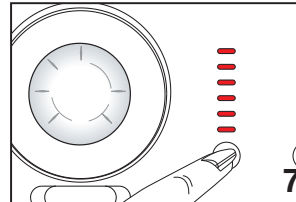
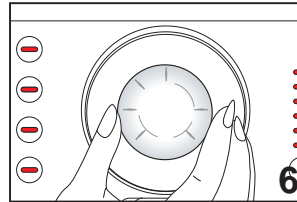
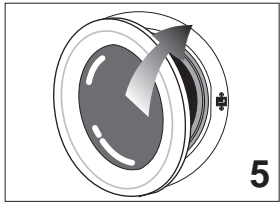
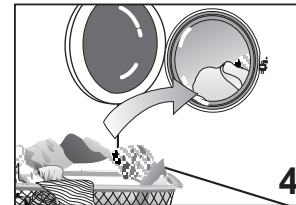
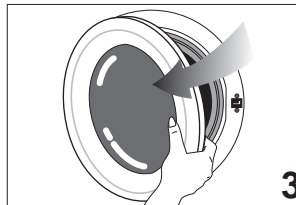
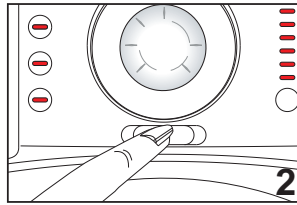
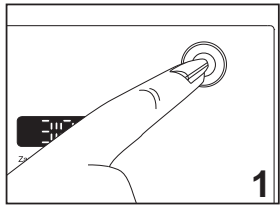

## Program selection

Programme	Fabric type	Program Description	Max Load (kg)	Program Duration (~min)	Water Consumption (l)	Energy Consumption (kWh)	Prewash	Quick Wash	Extra Rinse	Anti-Creasing	Detergent Dispenser
Cotton 90	Heavy soiled fabrics made from cotton or linen, heat resistant	Pre-wash / 3 rinses /3 intermediate spins / Final Spin	133	45	1.35	3.5	•	•	•	• (capacity 3 kg)	I+II
Cotton 60*	Normal soiled fabrics made from cotton or linen, heat resistant	Main wash /3 rinses /3 intermediate spins / Final Spin	130	45	0.66	3.5	•	•	•	• (capacity 3 kg)	II
Cotton 40	Lightly soiled fabrics made from cotton, non-color fast	Main wash /3 rinses /3 intermediate spins / Final Spin	128	45	0.30	3.5	•	•	•	• (capacity 3 kg)	II
Intensive 60	Heavy soiled fabrics made from cotton or linen, heat resistant	Main wash /4 rinses /4 intermediate spins / Final Spin	167	50	1.04	3.5			*	• (capacity 3 kg)	II
Synthetics 60	Normal soiled fabrics made from cotton/synthetics blended, heat resistant	Main wash /3 rinses /3 intermediate spins / Final Spin	110	40	0.60	2	•	•	•	• (capacity 1.5kg)	II
Synthetics 40	Lightly Soiled Easy care fabrics made from cotton, synthetics or blended fabrics (non-color fast)	Main wash /3 rinses /3 intermediate spins / Final Spin	104	40	0.33	2	•	•	•	• (capacity 1.5kg)	II
Synthetics Cold	Very Lightly Soiled Easy care fabrics made from cotton, synthetics or blended fabrics (non-color fast)	Main wash /3 rinses /3 intermediate spins / Final Spin	83	40	0.10	2	•	•	•	• (capacity 1.5kg)	II
Curtain 40	Special programme for curtains	Pre-wash /Main Wash /no intermediate spins / special final spin profile for anti-creasing	160	55	0.38	2	*		*	* (capacity 2kg)	I+II
Delicate 40	Sensitive, easy care fabrics made from cotton, synthetics or blended fabrics	Main wash /3 rinses /no intermediate spins / Final Spin	70	40	0.35	1.5			•	• (capacity 1kg)	II
Woolen 40	Hand wash marked easy care, blended fabrics	Main wash /3 rinses /1 intermediate spin / Final Spin	62	35	0.25	1			•		II
Woolen Cold	Hand wash marked wool and easy care, blended fabrics	Main wash /3 rinses /1 intermediate spin / Final Spin	50	35	0.05	1			•		II
Handwash 30	Special programme for Hand wash marked wool and silk	Main wash /2 rinses /no intermediate spin / Final Spin	46	25	0.10	1					II
Mini 30	Lightly Soiled less amount fabric	Main wash /2 rinses /1 intermediate spin / Final Spin	30	30	0.10	1.5					II
Rinse	Rinsing	3 rinses /3 intermediate spin / Final Spin in Cotton profile	42	30	0.10	3.5					-
Spin	Spinning	Final Spin in Cotton profile	9	-	0.05	3.5					-
Drain	Draining	Drain	2	-	-	-					-

• Options available

\* Default function selection

Cotton 60\*:Energy Labelling program acc. to EN 60456:1999 ve IEC 60456 Ed.4 2001

Depending on water, textile and ambient conditions the actual values given on or with the machine can deviate from the declared standard values, as they are tested according to the laboratory conditions

## Child Lock

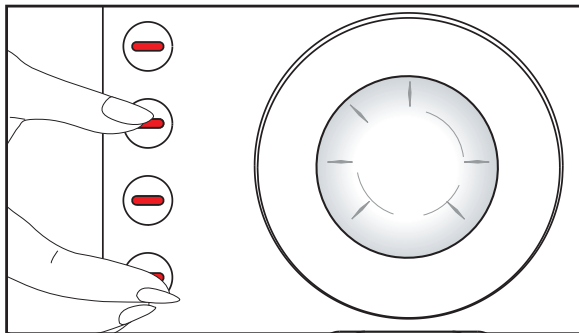

To prevent the knobs from being played by your children you may activate “child lock” option. Activating the “Child Lock” option prevents any change from being made to a set program.

To activate child lock, press both on the second and the fourth auxiliary function buttons together for 3 seconds after the machine starts the washing operation.

After activating the Pre-wash auxiliary function, its led will be blinking.

Only On/Off button will be in operation when the child lock option is selected.

To deactivate child lock, re-press same auxiliary function buttons (second and fourth) for 3 seconds.

In order to open the door at the end of the washing program or to change program selection, child lock must be deactivated if selected.



When the machine is turned on, the led of the selected program on the knob will light up.

If there is no light on the program selection knob, it means that program selection knob is stuck between two programs. In that case, the knob should be adjusted on the correct program again.

If the program selection knob is turned while the machine is on and executing the selected program, all led on the program selection knob will be off. When the knob is set to selected program again, related led will be on.

## On/Off

When you press the On/Off button, your machine is ready to select the desired program. The door open led will be on and the door is ready to open. When the desired program is selected, related spin speed can be adjusted and the duration of the program can be observed on the display. To switch the machine off, repress the On/Off button.

Washing can only then be started when the  button is pressed.

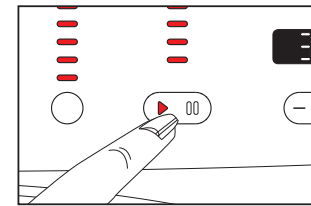
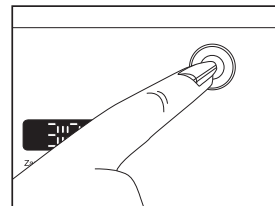

Pressing the On/Off button does not mean that the washing operation is started!  
To start the washing, press the Start/Cancel/Pause button!

## Auxiliary Function Selection

It is not possible to activate all auxiliary functions in all wash programs. If any auxiliary function is selected, its led will be on. It is restricted to select some auxiliary functions together. For example, if the cotton program is selected, “quick wash” and “pre-wash” functions can not be selected at the same time. If “Pre-wash” button is selected first and the “Quick wash” function next, the led of the pre-wash function will be off as it is not active any more.



You can cancel the auxiliary function, only by canceling the program.

## Program Follower

If the machine is on, a program can be followed by means of the program follower. If a washing step is over and the next step is started, the led of the previous step will continue to light.

It means if the washing operation is finished, all related washing steps on the program follower will be on. Pre-wash button led will be on, only if this auxiliary function is selected.

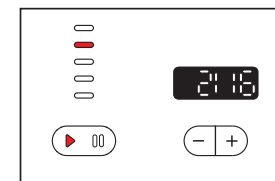

## Additional Laundry

Press the Start/Cancel/Pause button. If the water level does not exceed the limitations, in 1 to 2 minutes door open led will come on. It means the washing machine is ready to add laundry.

If door open led is not lit up after 1-2 minutes, it means the water level inside the machine is too high and it is not allowed to open the door and add laundry. (Look at Program Cancelling).

If you change your mind as not adding laundry, press Start/Cancel/Pause button again to let the program continue.

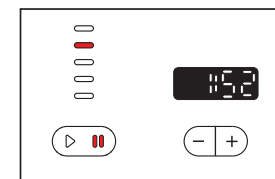

## End of the Program

If all the wash programs are finished, all the leds on the program follower will be on. "1-2 minutes" for door open is displayed on remain time display. After 1-2 min door open led will light up.

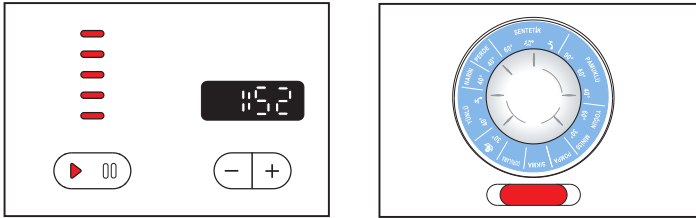

At the end of the washing, all related leds on the control panel will be on. Related duration time of the selected program is displayed and the machine is ready to start again.  
To switch off the machine, press the On/Off button.

## Unloading the machine

Machine stops automatically after all the programs are finished. Turn off the tap. In 1-2 min, after the door open led lights up, press the door open button and open the door. Press the On/Off button to switch off the machine. Unload the machine and leave the front door open. Check to see if there is any water left in the door hood. If so, remove with a soft cloth.

## Time Delay

By using the time delay buttons, starting time of any program can be delayed. Time delay can be set at intervals of 30 min.

On the display, the delayed starting time is added to the duration of the program.

For example, if the program duration is 2 hours and 16 min and you delayed the program for 2 hours, the display will show "4:16". After the time delay is set, press Start/Pause/Cancel button. The washing period will be started after 2 hours

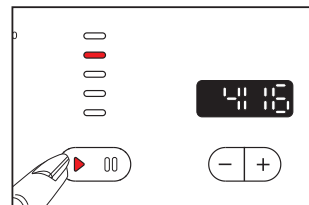
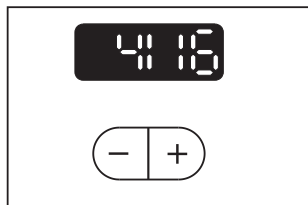
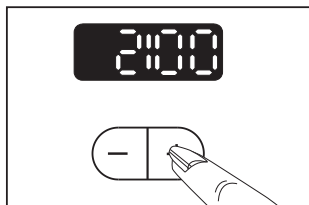
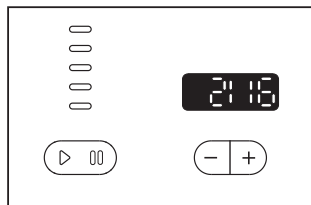

## Program Cancelling

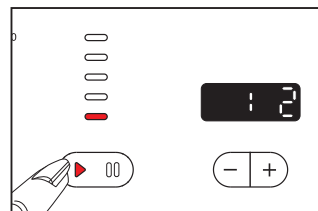
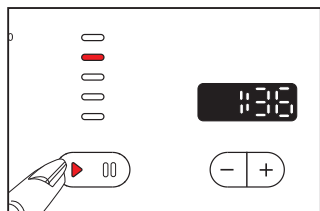
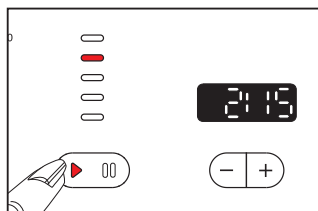

If the program has not started yet, you can cancel the selected program by pressing Start/Pause/Cancel button for 3 seconds. After 3 seconds the led of the Start/Pause/Cancel button will be off and the led of the selected program will be on, where it is possible to set a new program

If the program has started and you want to cancel it, press Start/Pause/Cancel button for 3 seconds. The program will move to the "spin" step and related led on the program follower will be on. Machine will start to pump for draining and the door can be opened after the door open led is on.

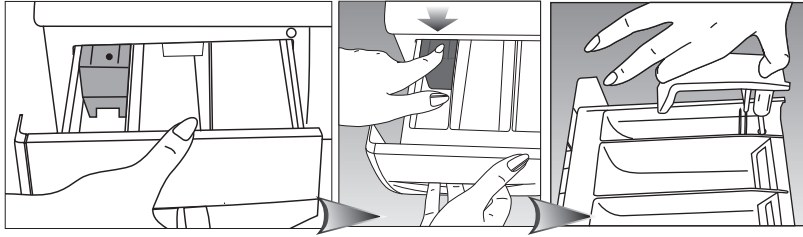

### Detergent dispenser

To clean the detergent residues, remove the detergent dispenser from its place by pressing on the area marked on siphon. Wash the dispenser with water and also clean the dispenser housing before inserting the dispenser to its place.

### Siphon

Clean the siphon (coloured piece in the dispenser) every 30-40 washes. Pull out the siphon by holding from its edges. To prevent clogging, clean the softener residues thoroughly and make sure that the siphon fits into its place completely before any operation.

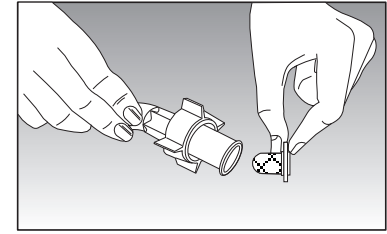
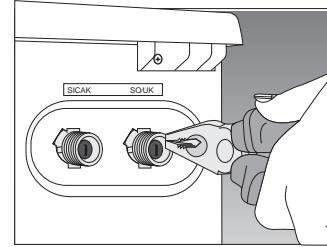

### Water intake filter

At the end of the water intake connection module and water inlet hose-tap side, there exists filters. These filters prevent any dirt and objects passing into the machine. It is advisable that these filters should be cleaned every 30-40 washes. To clean the filter, first turn the tap off. Then, disconnect the hose and clean the filter with a thin brush. If the filter is very dirty, you may clean it by pulling out with pliers. To clean the filter at the tap side of the hose, pull it out by hand and clean the filter under the tap water.

### Hose

To prevent any leakage, have a technician to control the hoses every two years. If the machine is placed at cold ambient temperatures, the water remaining inside the pump and hoses should be removed from the filters. Also to prevent freezing, empty the water intake hoses by disconnecting from taps.

### Drum

Do not leave any metal objects (pins, needles, etc.) inside the drum. These objects may cause rust on the drum surface. Do not clean the drum with scratching elements.

## Cleaning the pump filter

Remove the plug. Open the filter cover by pushing on the marked area shown beside.



**Attention! Hot water danger!** It is possible that app. 15 lt, 90 hot water is inside. Be careful while taking out the filter!

Before taking out the filter, drain the water by means of pump drain hose. Take out the pump drain hose from its place. Take a proper holder to drain the water inside and then open the pump drain hose plug.

When all water is discharged, insert the plug into the pump hose again and replace the pump drain hose in its place.

Open the filter while turning it counterclockwise, drain the left water (max 30 ml) on to the filter cover. If there are any residual parts inside the filter, take them out and clean the filter before replacing it. Then, place the filter while turning it clockwise and at the end, close the filter cover by pushing on the marked area again.



**Attention!** If the filter and hose plug do not fit into its place, water will leak out from the filter.

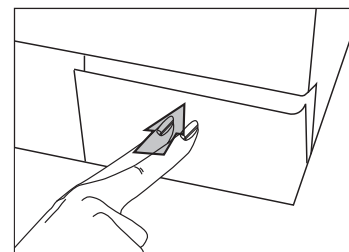
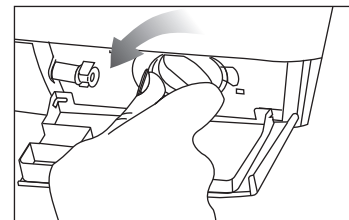
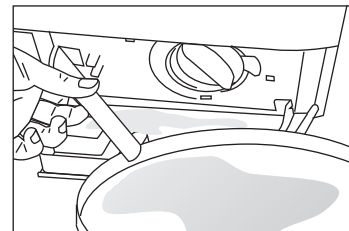
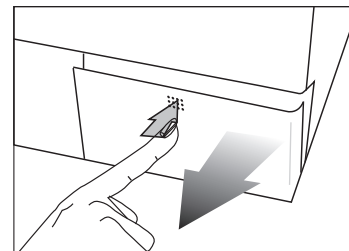

## Part 6: | Determining location and installation

### 1. Removing transport safety bolts at the rear of the machine

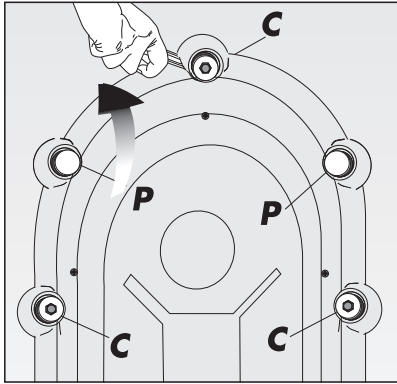

The transport safety bolts must be removed before any operation of the machine. Bolt heads, marked "C".

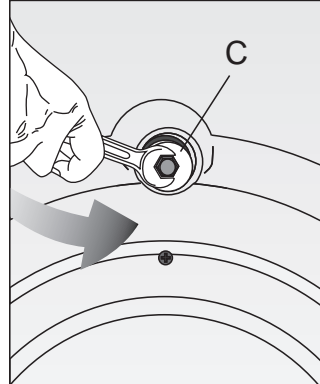

"C", should be turned in a anti clockwise direction until the bolt can be partially withdrawn.

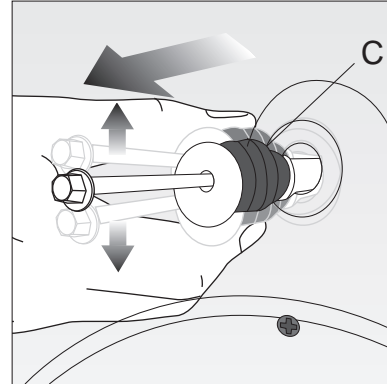

Remove transport safety bolts and rubber bushes by pulling outwards. (A up/down action and a small squirt of washing up liquid should ease removal.)

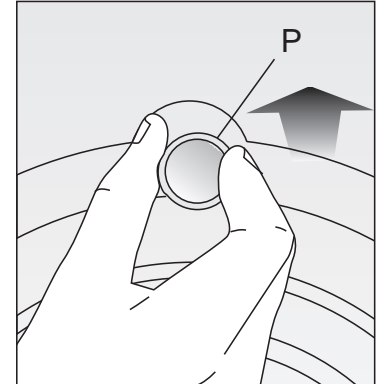

Plastic plugs, supplied inside the protective bag and designated as "P", should be placed in the safety bolt holes according to the direction shown.



#### **Attention!**

**Please keep the safety bolts for future transportation and reinstate them before transporting your machine. Never transport your machine without the transport bolts in position.**

**Never place your machine on a carpet. This prevents air circulation. The electrical components of the machine may overheat and may cause damage.**

## 2. Feet adjustment

In order for quiet and stable operation, the machine should be placed properly and leveled on its feet. Your machine comes with two adjustable feet. If the machine is unstable, loosen the plastic counternut and screw or unscrew the adjustable foot until the machine is leveled perfectly. After positioning, tighten the counternut for stability.

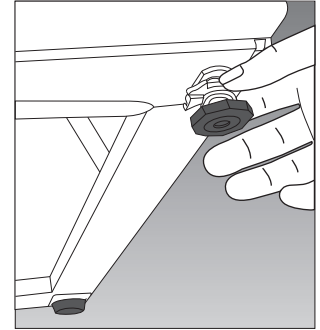

## 3. Water connections

### a) Water inlet hose

For proper operation, the pressure of water should be between 1 and 10 atm. (1 atm corresponds to more than 8 liters per minute flow rate at fully open tap.)

To prevent water leaks sealing washers are supplied with the water inlet hose inside the machine, place these on each of the hose ends and tighten both ends fully.

In order to prevent any water leak damages, keep the water taps closed when not in use. Connect the cornered end of the hose to the machine water inlet.

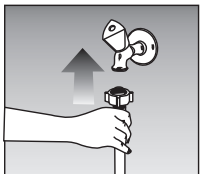
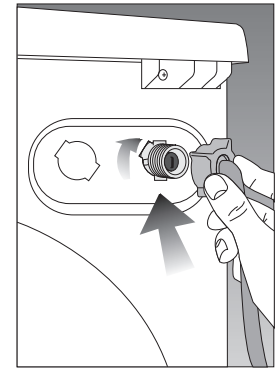

Connect the cold water using the hose with blue printing and connect the hot water using the hose with red printing.

## b) Water drain hose

Water drain hose could be placed either at the side of the bath tub, or directly to the drain. The hose should not be bent. Water drain hose should be secured with the elbow so that it would not fall down on the ground.



The hose should be placed between 40 and 100 cm. from the ground.

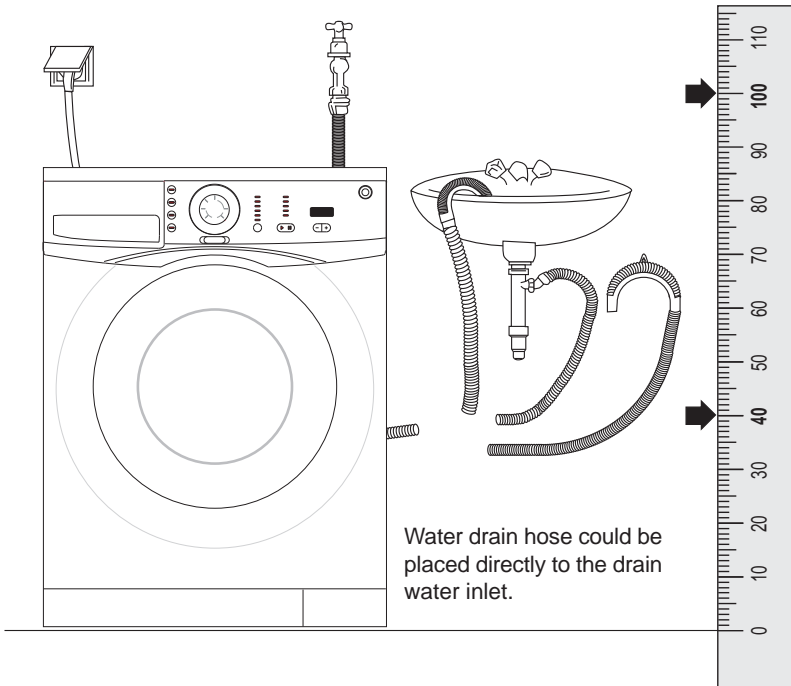

## 4. Electrical connection

Connect the power cord to the appropriate electrical system which is being supported by the maximum voltage and current rating indicated on the rating plate placed inside the kick plate.

Look! Page 1, Steps before operating Fullautomatic Washing Machine and safety precautions.

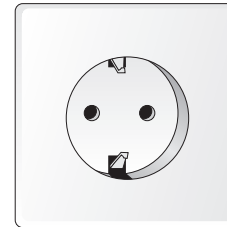

**Make sure that you have grounded power outlet.**

## Part 7: | Helpful tips on stain removal

The following stain removing tips are approximate and can only be used at the washable fabrics. Please consult the washing information of the fabric manufacturer.

Ratios are approximated.



**Alcoholic beverages:** Wipe the fabric first with water, then water-glycerine solution and rinse with vinegar-water solution.



**Shoe polish:** Without harming the fabric, remove the stain carefully and grind it with detergent. If this doesn't help, prepare a water to alcohol solution (2 to 1) and rub the fabric, then wash it with warm water.



**Tea and coffee:** Pour hot water on to the stain and the fabric is white, pour some bleach and rinse it with water.



**Bubblegum:** Harden the gum stain by putting an ice on it. Then scrape off the stain carefully.



**Chocolate and cocoa:** Place the fabric into cold water for a period of time. Rub it with soap or detergent and wash it with the warmest water that the fabric can withhold. If any grease stain leftover wipe it with oxygen water.



**Tomato paste:** Scrape the hardened paste and leave the fabric for 40 minutes into cold water. Rub it with detergent and wash.



**Egg stain:** If the stain is hardened scrape the stain and wipe it with wet sponge or a soft cloth. Rub it with detergent and wash with cold water.



**Grease stain:** Scrape the stain and rub it with detergent. Then wash the fabric with warm water.



**Mustard:** Use glycerin and rub the fabric with detergent. If unsuccessful, wipe the stain with alcohol. (Colored and synthetic fabrics need 2 cups water and 1 cup alcohol solution.)



**Blood stain:** Leave the fabric for 30 minutes in the cold water. Use ammonia solution to remove the stain. (4 liters water-3 spoonful of ammonia.)



**Ice-cream, milk and cream:** Place the fabric into cold water for a period of time. Rub it with soap or detergent and wash it with the warmest water that the fabric can withhold. If any grease stain leftover wipe it with oxygen water.



**Mildew:** Do not let mildew stains stay for long periods of time. Place the fabric into cold water for a period of time. Rub it with soap or detergent and wash it with the warmest water that the fabric can withhold. If any grease stain leftover wipe it with oxygen water.



**Fruit:** Pour cold water on to the stain and do not use warm water to rinse. Let it sit for 2 hours and wipe it with white vinegar and rinse.



**Ink:** Let the cold water run on the stain and wait until the stain is gone. Later rub it with lemon juice and detergent, let the stain stay for five minutes and rinse the fabric.



**Grass stain:** Rub the stain with detergent. If the fabric lets, use bleaching element. Wools should be wiped with alcohol.



**Paint:** Use thinner to remove the stain. Put a cotton cloth on the wool fabrics. Rub the stain with detergent and rinse with cold water.



**Burnt stains:** Use bleach if permissible. For wool fabrics place a oxygen water inserted cotton cloth on the stain and iron. Rinse completely and wash the fabric.

## Part 8: | Before calling service



### You turned the machine on, but the leds are off on the panel.

Check the grounding on the power cable or a blown fuse. Check the front door proper closure.



### Machine does not take water.

Check the front door for proper closure. Either taps are closed or water intake filters are clogged.



### Taken water is directly discharged.

Check if the discharge hose placed as described in the users manual or not.



### Water coming from beneath the machine.

Check the water intake and drain hoses. Tighten the connections. The washers of the hoses may be worn out. If non of the both, the pump filter is not closed properly.



### Foam coming out of the detergent dispenser.

Check whether your detergent is suitable for automatic machines. Next time use less detergent.



### Pump does not drain water.

Clean the pump filter. Check whether the drain hose is bent or not. If there is need to clean the pump filter, refer to the pump filter cleaning section of the manual.

## Descriptions of the international textile care label (ITCL) symbols



Washing temperature

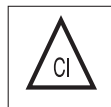

Bleach can be used



Do not use bleach



Do not machine wash

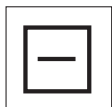

Dry on horizontal surface



Do not wash



Dry clean



Chemicals can be used



No dry cleaning



No spin



Can be washed at centrifugal machine



Do not wash centrifugal machine



Line dry



Iron permitted



Do not iron



Warm iron



**This product  
has been manufactured at  
environmental friendly modern  
facilities.**